

DVC-1000 USER Manual

Intel® RealSense™ 3D Camera

Record of Revision

| Version | Date | Page | Description | Remark |
|---------|------------|-------------|------------------|--------|
| 1.00 | 2021/01/07 | All | Official Release | |
| 1.10 | 2021/01/08 | 1, 2, 6 | Update | |
| 1.20 | 2023/04/14 | i, iv, 1, 4 | Update | |

Disclaimer

This manual is released by Vecow Co., Ltd. for reference purpose only. All product offerings and specifications are subject to change without prior notice. Vecow Co., Ltd. is under no legal commitment to the details of this document. Vecow shall not be liable for direct, indirect, special, incidental, or consequential damages arising out of the use of this document, the products, or any third party infringements, which may result from such use.

Declaration of Conformity

FCC This equipment has been tested and found to comply with the limits for a Class A digital device, pursuant to part 15 of the FCC Rules. These limits are designed to provide reasonable protection against harmful interference when the equipment is operated in a commercial environment. This equipment generates, uses, and can radiate radio frequency energy, and if it is not installed and used in accordance with the instruction manual, it may cause harmful interference to radio communications. Operation of this equipment in a residential area is likely to cause harmful interference in which case the user will be required to correct the interference at his own expense.

CE The products described in this manual comply with all applicable European Union (CE) directives if it has a CE marking. For computer systems to remain CE compliant, only CE-compliant parts may be used. Maintaining CE compliance also requires proper cable and cabling techniques.

Copyright and Trademarks

This document contains proprietary information protected by copyright. No part of this publication may be reproduced in any form or by any means, electric, photocopying, recording or otherwise, without prior written authorization by Vecow Co., Ltd. The rights of all the brand names, product names, and trademarks belong to their respective owners.

Order Information

| Part Number | Description |
|-------------|--------------------------------------------------------------------------------------------------------|
| DVC-1000 | Industrial-grade 3D Camera powered by Intel® RealSense™ Depth Module D430, PoE/M12 Power input, 12V DC |

Table of Contents

| | | |
|-------------------|--------------------------------------|-----------|
| CHAPTER 1 | GENERAL INTRODUCTION | 1 |
| | 1.1 Overview | 1 |
| | 1.2 Features | 1 |
| | 1.3 DVC-1000 Specification | 2 |
| | 1.4 Mechanical Dimension | 3 |
| CHAPTER 2 | GETTING TO KNOW YOUR DVC-1000 | 4 |
| | 2.1 Window Version Utility | 4 |
| | 2.2 Optional Accessory Kit | 4 |
| | 2.3 I/O and Indication | 4 |
| CHAPTER 3 | SYSTEM SETUP | 5 |
| | 3.1 Installing DVC-1000 | 5 |
| CHAPTER 4 | DVC-1000 Utility | 7 |
| | 4.1 Window Version Utility | 7 |
| | 4.2 Linux Version Utility | 27 |
| APPENDIX A | Reset Camera | 30 |

1

GENERAL INTRODUCTION

1.1 Overview

DVC-1000 is an industrial grade IP67 3D Camera include 2D RGB camera module, Intel® RealSense™ Depth Module D430 camera module, and Intel® RealSense™ vision processor module. DVC-1000 provides Lockable PoE Ethernet power input port via 12V@2A or M12 power input connector. DVC-1000 is suitable for using in robotics, logistics, AGV, AMR, 3D monitoring and inspection, real-streaming video, AI surveillance, real-time inspection, and Industry 4.0/IIoT applications.

1.2 Features

- 3D Embedded Vision Camera powered by Intel® RealSense™ technology
- Rugged design with IP67-rated mechanism chassis
- Flexible supports 12V DC or IEEE 802.3at PoE⁺ (25.5W/48V) Power Input
- Support M12 Power Input Connector
- Compact Size Design

1.3 DVC-1000 Specification

| Depth Module | |
|--------------------------|---------------------------------------------------------------------------------------------------------------------------------------------------------------|
| Technology | Active Stereoscopic |
| Working Distance | It may vary for calibration, scene, and lighting condition. <ul style="list-style-type: none"> • Max : 10 meters • Min : 0.105 meters |
| Resolution | 1280 x 720/640 x 480/480 x 270/424 x 240 |
| Frame Rate | Up to 60 fps |
| Shutter Type | Global Shutter |
| FoV (H x V x D) | 87°±3° × 58°±1° × 95°±3° @HD Resolution |
| Z Accuracy | ≤ 2%, up to 2 meters and 80% of FoV |
| Depth Sensor | OmniVision OV9282 |
| RGB Module | |
| Resolution | 1280 x 720/640 x 480/424 x 240 |
| Frame Rate | Up to 60 fps |
| FoV (H x V x D) | 69.4° x 42.5° x 77°(± 3°) |
| Color Sensor | OmniVision OV2740 |
| Illumination | |
| Type | Infrared |
| Wavelength | 850nm |
| Power | |
| Input | <ul style="list-style-type: none"> • DC 12V • PoE⁺ (25.5W/48V) (Compliance IEEE 802.3at PoE⁺) |
| Connector | <ul style="list-style-type: none"> • PoE : RJ45, Lockable connector • DC 12V : A-coded M12 |
| Network | |
| LAN | 10/100/1000 Ethernet, IEEE 802.3at PoE supported |
| Software Support | |
| OS | <ul style="list-style-type: none"> • Host : Ubuntu 16.04 • Client : Windows 10, Ubuntu 16.04 |
| SDK | Intel® RealSense™ SDK 2.0 |
| Mechanical & Environment | |
| Dimensions (mm) | 112.6 x 106.6 x 43 |
| Operating Temperature | 0°C to 40°C |
| Storage Temperature | -40°C to 70°C |
| Mounting | Tripod |
| EMC | CE, FCC |

1.4 Mechanical Dimension

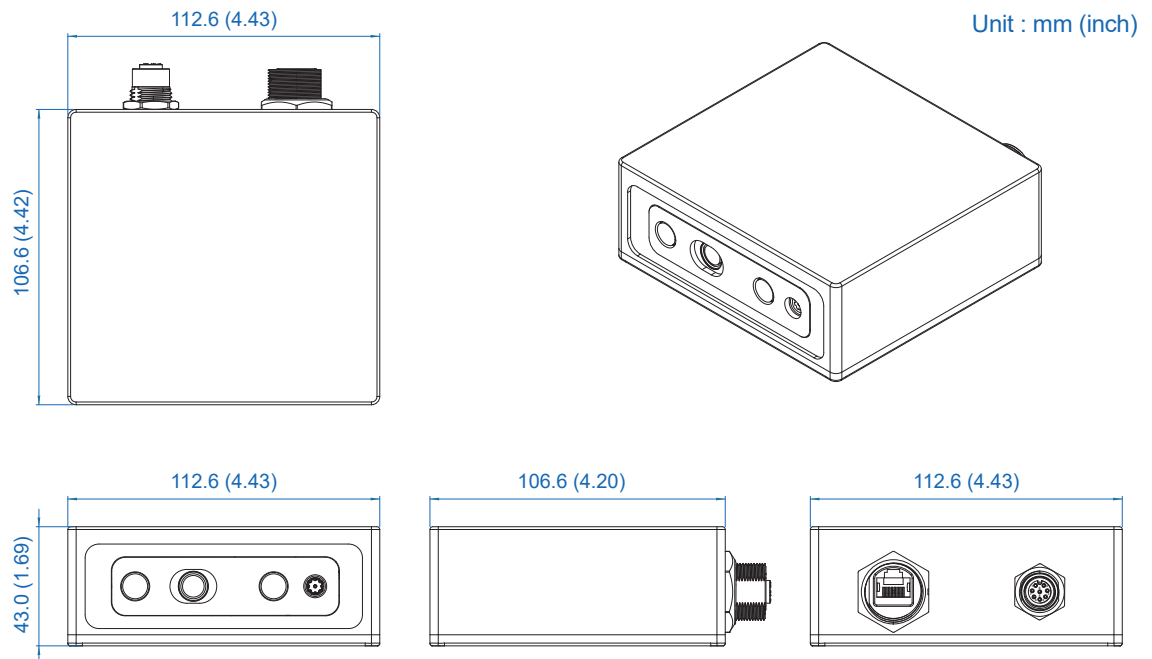

2

GETTING TO KNOW YOUR DVC-1000

2.1 Window Version Utility

| Item | Description | Qty |
|------|-------------------------------------------------------------|-----|
| 1 | DVC-1000, Intel® RealSense™ Camera | 1 |
| 2 | Accessory box, which contains Vecow Drivers & Utilities DVD | 1 |

2.2 Optional Accessory Kit

| P/N | Description |
|----------------|----------------------------------------------------------------|
| 61-1C10808-151 | DVC-1000 Lockable External PoE/LAN Cable |
| 61-1C20403-001 | DVC-1000 M12 to 3Pin terminal block External Power Input Cable |

2.3 I/O and Indication

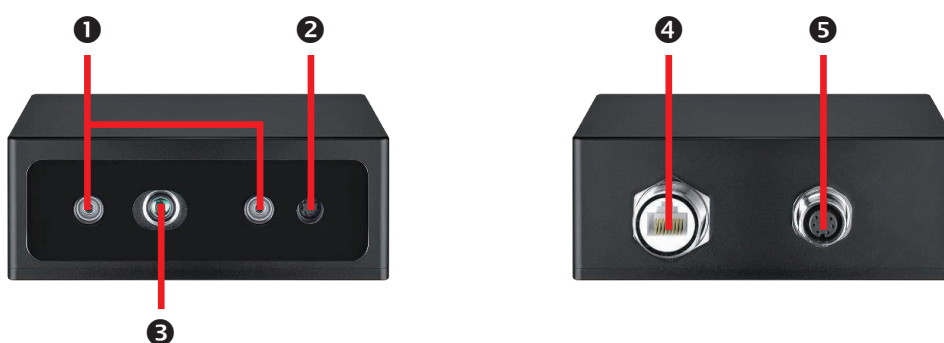

| No. | Name | Functions |
|-----|--------------------|----------------------------------------------------------------------|
| 1 | IR Stereo Sensor | Receives IR image. |
| 2 | RGB Sensor | Receives RGB image. |
| 3 | Depth Sensor | Receives Depth image |
| 4 | Ethernet Interface | Provides power and data transmission through Cat-5e Ethernet cables. |
| 5 | M12 Connector | Connects to a M12 cable for power input or Ethernet reset. |

3

SYSTEM SETUP

3.1 Installing DVC-1000

3.1.1 System Requirement

We recommend using the following operating systems when accessing DVC-1000.

- Suggest to use Intel® 7th Generations Core™ i5 processors or above
- Ubuntu Linux 16.04 LTS or Microsoft Windows 10 64-bit System
- Internet Explorer 10.0 (or equivalent) or above when using Microsoft Windows 10

3.1.2 Peripheral Components Requirement

Before install DVC-1000, you need to prepare bellow items.

| No. | Items |
|-----|-------------------------------------------------------------------------------------------------------|
| 1 | Gigabit PoE Switch (IEEE 802.3at) |
| 2 | A Cat-5e Gigabit Ethernet Cable or M12 Power Input Cable (An alternative option for power supply.) |
| 3 | PC/Laptop |

3.1.3 Installation Guide

There are two kinds of power input methods : M12 PoE (Power over Ethernet) or M12 to 3-Pin terminal Interface. We recommend using PoE as the standard scenario. For power supply/data transmission channel separation, optionally use M12 cable.

Note : If customer want to use PoE power input, please use vecow utility to disable DHCP to change to static IP. (Camera default setting is DHCP on)

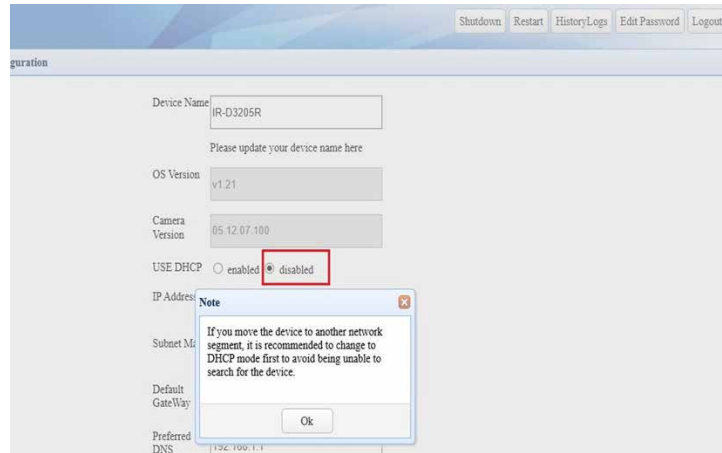

3.1.3.1 By PoE Power Input

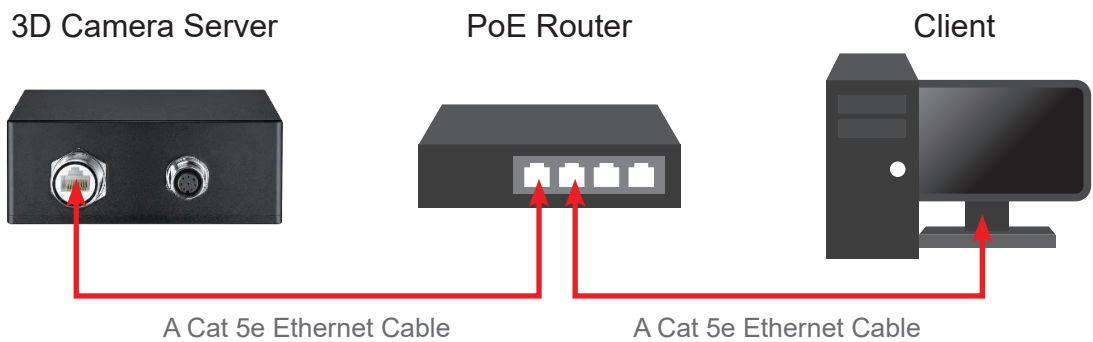

3.1.3.2 By M12 Power Input

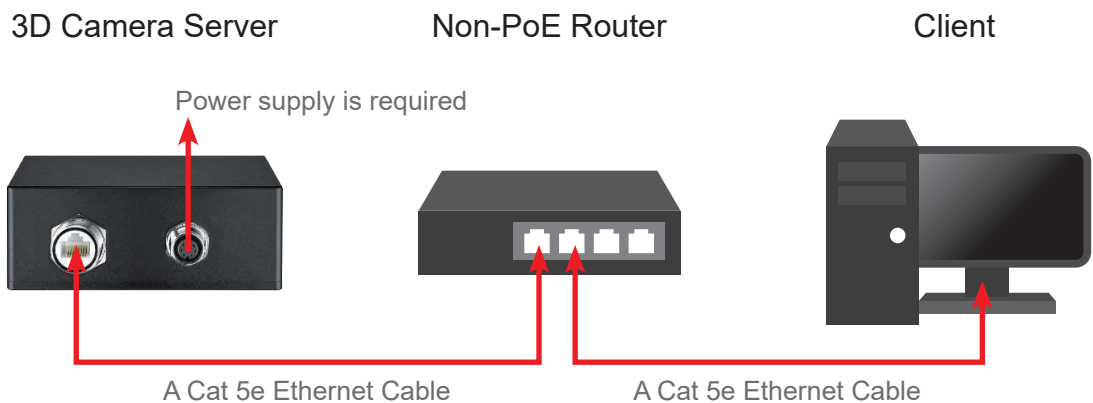

WARNING :

Please remove protect film on camera lens surface, this film is use for protect lens surface when shipping.

4

DVC-1000 Utility

4.1 Window Version Utility

Before using the device, please make sure turn off windows firewall, otherwise it will cause abnormal data transmission or loss.

4.1.1 Searching Camera IP Address

Please set up your camera and PC/laptop in the same domain during set up hardware environment. Open DVC-1000 Utility and click search device, then it will list all available devices.

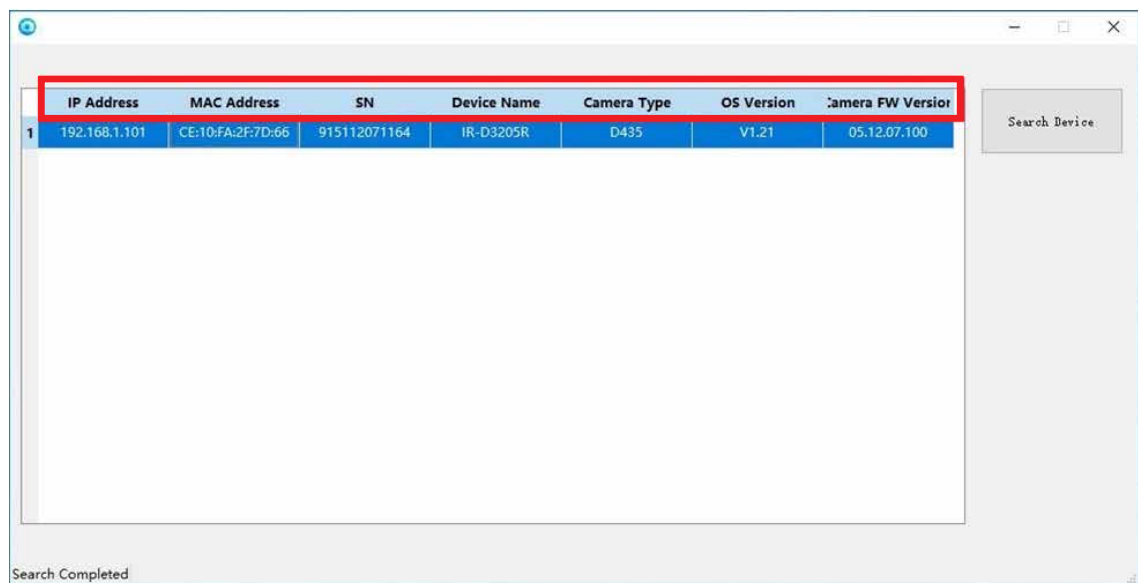

| | IP Address | MAC Address | SN | Device Name | Camera Type | OS Version | Camera FW Version |
|---|---------------|-------------------|--------------|-------------|-------------|------------|-------------------|
| 1 | 192.168.1.101 | CE:10:FA:2F:7D:66 | 915112071164 | IR-D3205R | D435 | V1.21 | 05.12.07.100 |

IP Address : The network IP is automatically assigned. You can disable the "DHCP" to change the IP Address.

MAC Address : Device MAC Address

SN : Displays the current camera SN number

Device Name : You can edit the device's name in the web page. The default device name is DVC-1000.

Camera Type : The camera SKU.

OS Version : The current DVC-1000 OS version.

Camera FW Version : The current camera firmware version.

4.1.2 Searching Camera IP Address

Step 1 Right click the mouse, Choose "Login Page".

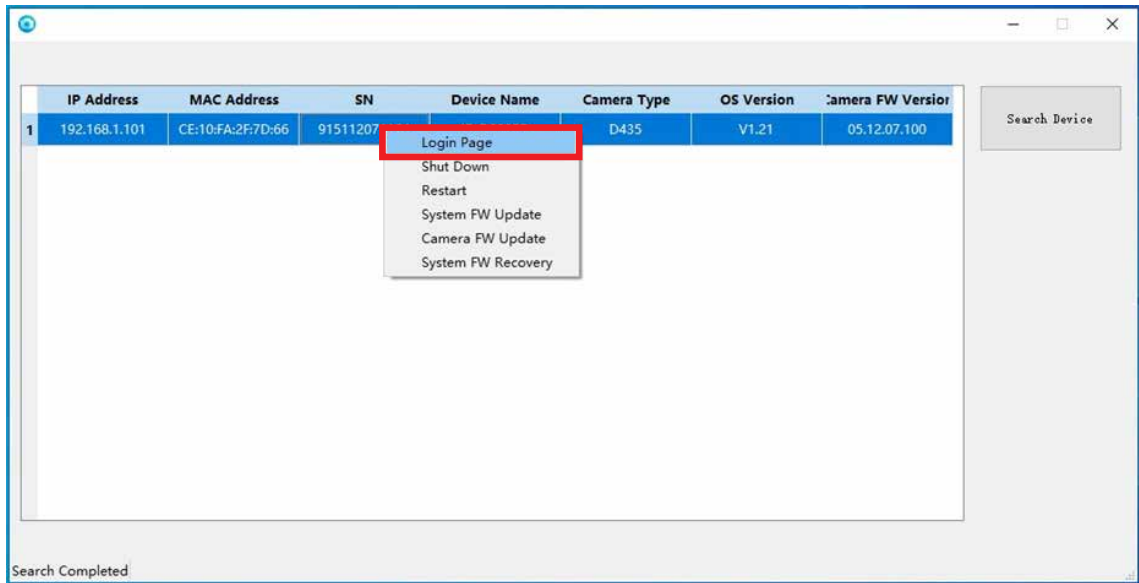

Step 2 Enter the default username and password and click "Login".

Default Username : admin

Default Password : admin

The screenshot shows a "Login to system" dialog box. It contains two input fields: a username field and a password field. The password field has a "Password" label and a visibility icon (an eye). Below the input fields are two buttons: "Login" and "Clear".

Step 3 Disable the "USE DHCP", a dialog box will pop up, then click "OK".

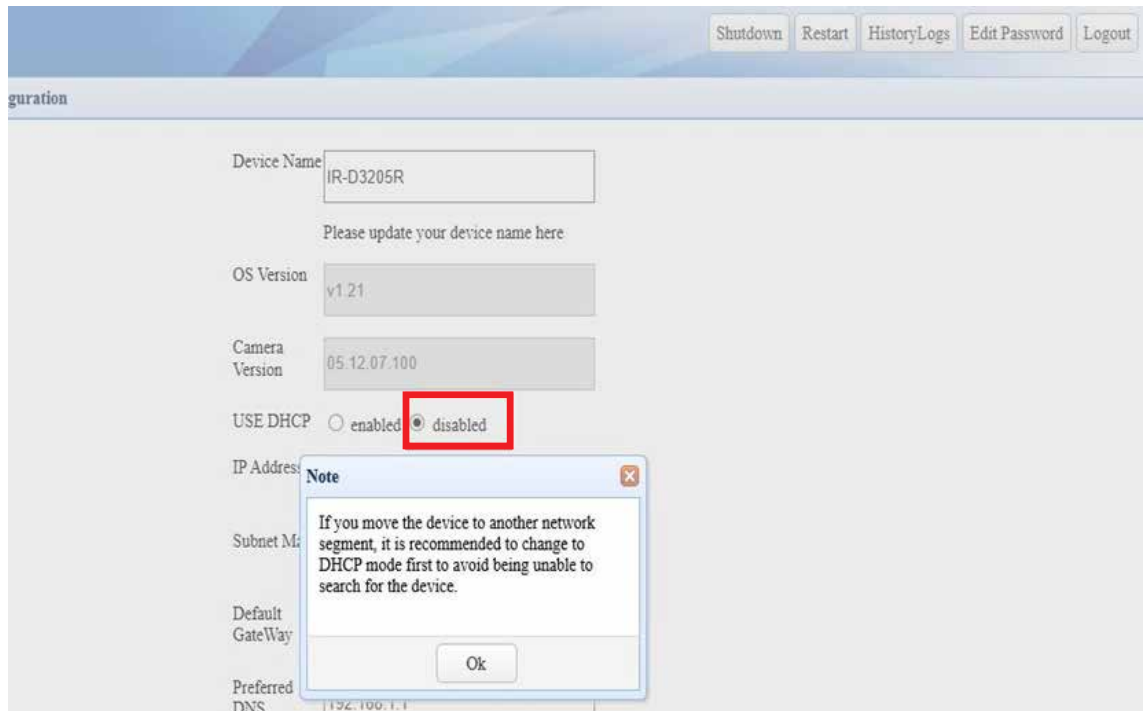

Step 4 Under the same domain, your IP address can be changed from 2 to 254. If IP is already exist, it will show message to ask for set up another new IP.

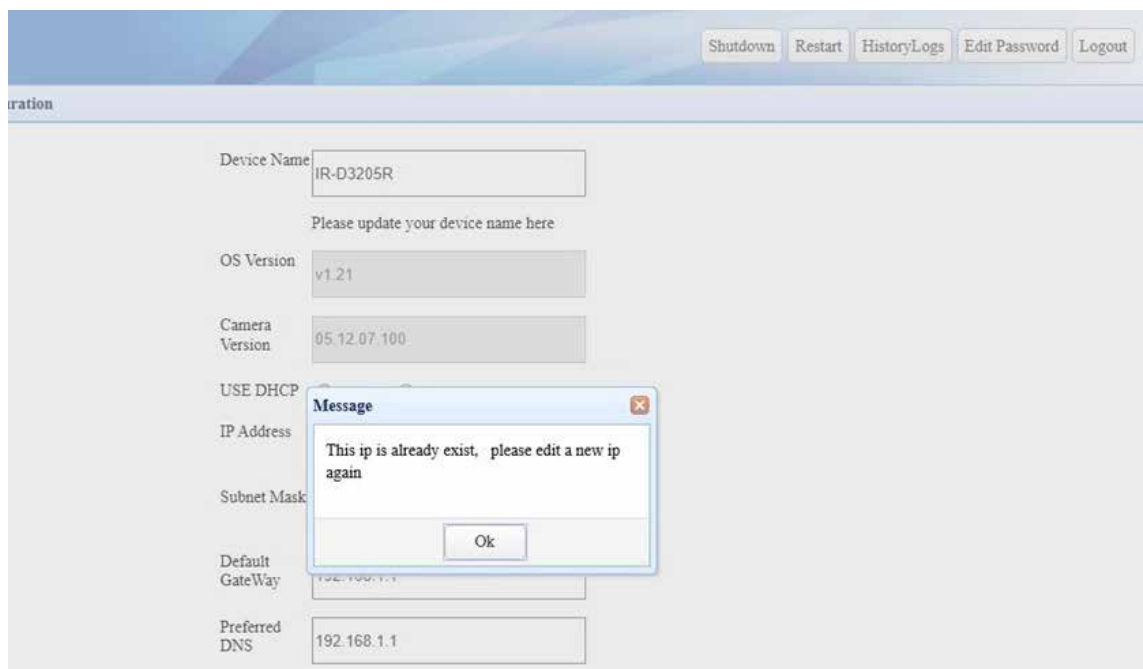

Step 5 Enter the new IP, and click "update config". When the progress bar shows 100%, the IP address changed successfully, then the device will be restart.

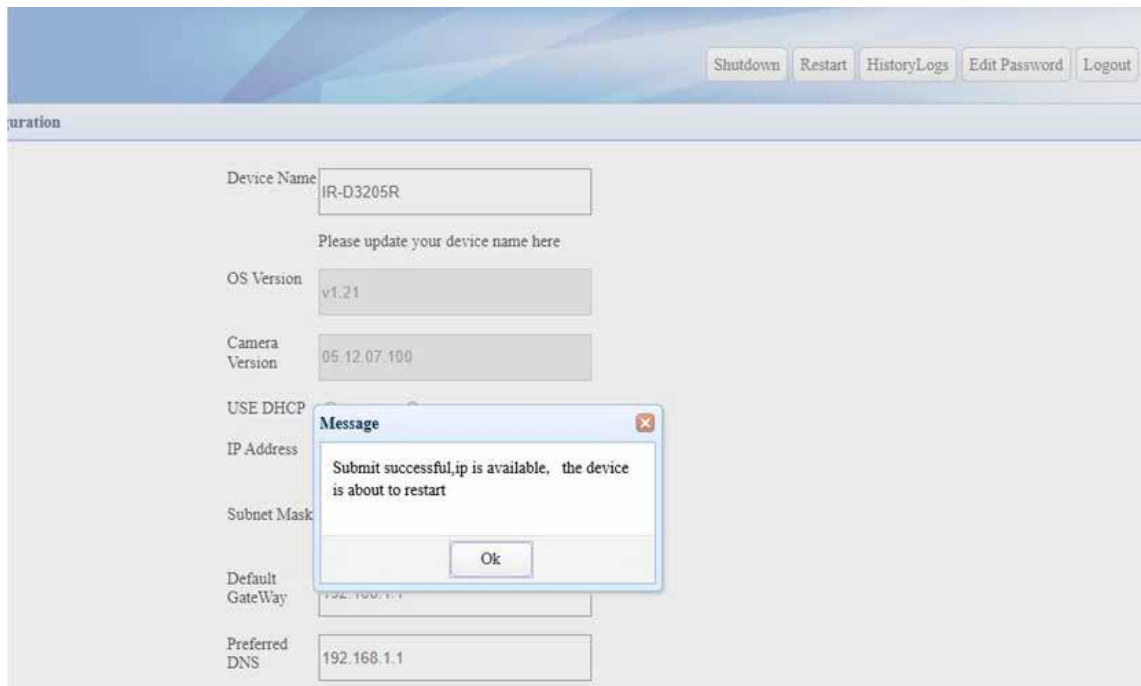

Step 6 Close the page and waiting for 30 seconds, in Vecow utility, search device again, make sure the IP address changed successfully.

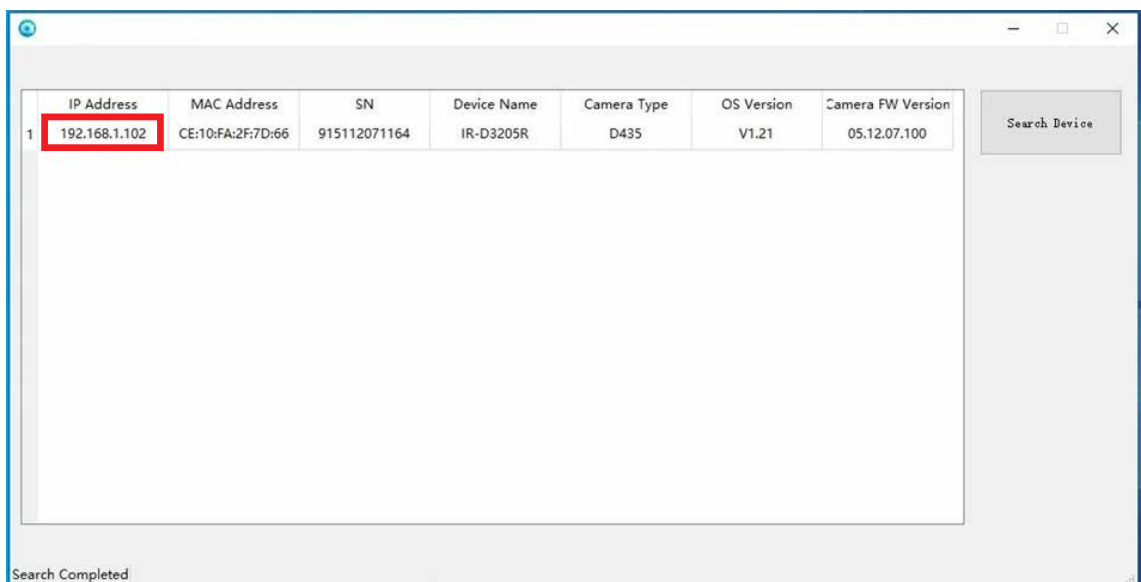

Step 7 Enter to the login page again, click "Historys Logs" to see change history.

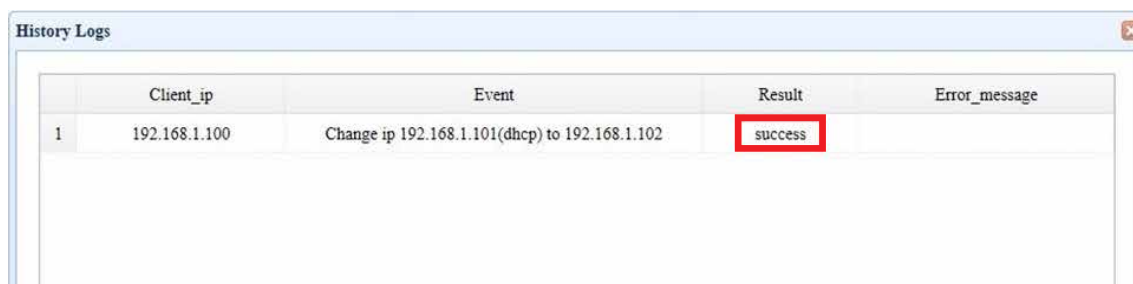

| | Client_ip | Event | Result | Error_message |
|---|---------------|------------------------------------------------|---------|---------------|
| 1 | 192.168.1.100 | Change ip 192.168.1.101(dhcp) to 192.168.1.102 | success | |

4.1.3 Edit password

We recommend that you change the login password immediately after you get the device.

Step 1 Enter to login page, Click "Edit Password".

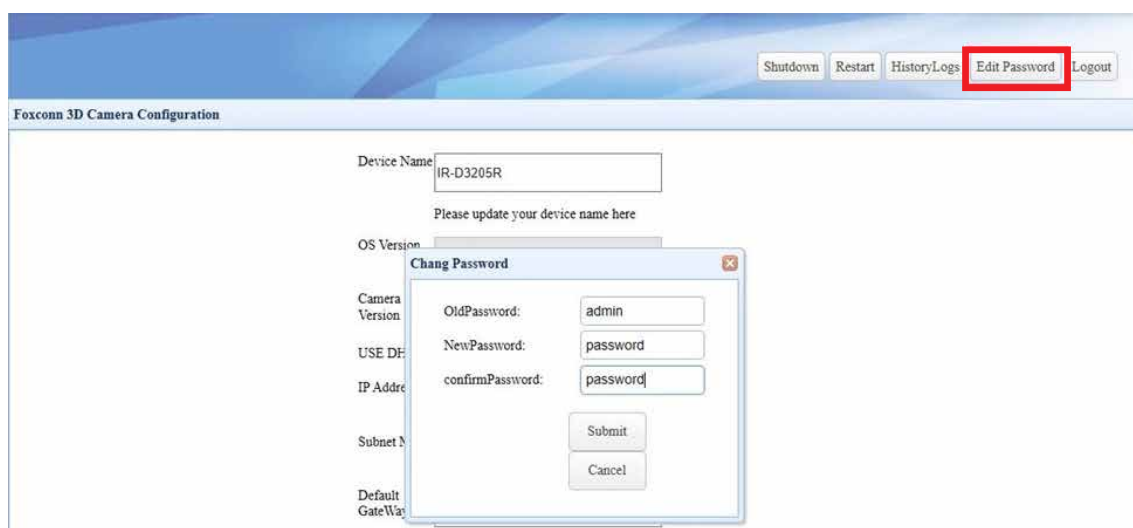

Step 2 Set your new password and click "Submit", A message indicating that the password has been successfully changed will pop up.



Note : User name is not allowed to be changed, only password can be changed.

4.1.4 Restore Factory Default Setting

Step 1 If you want to restore your device to factory setting, you just need to open Vecow utility and choose your device and enter to login page, then choose "restore factory".

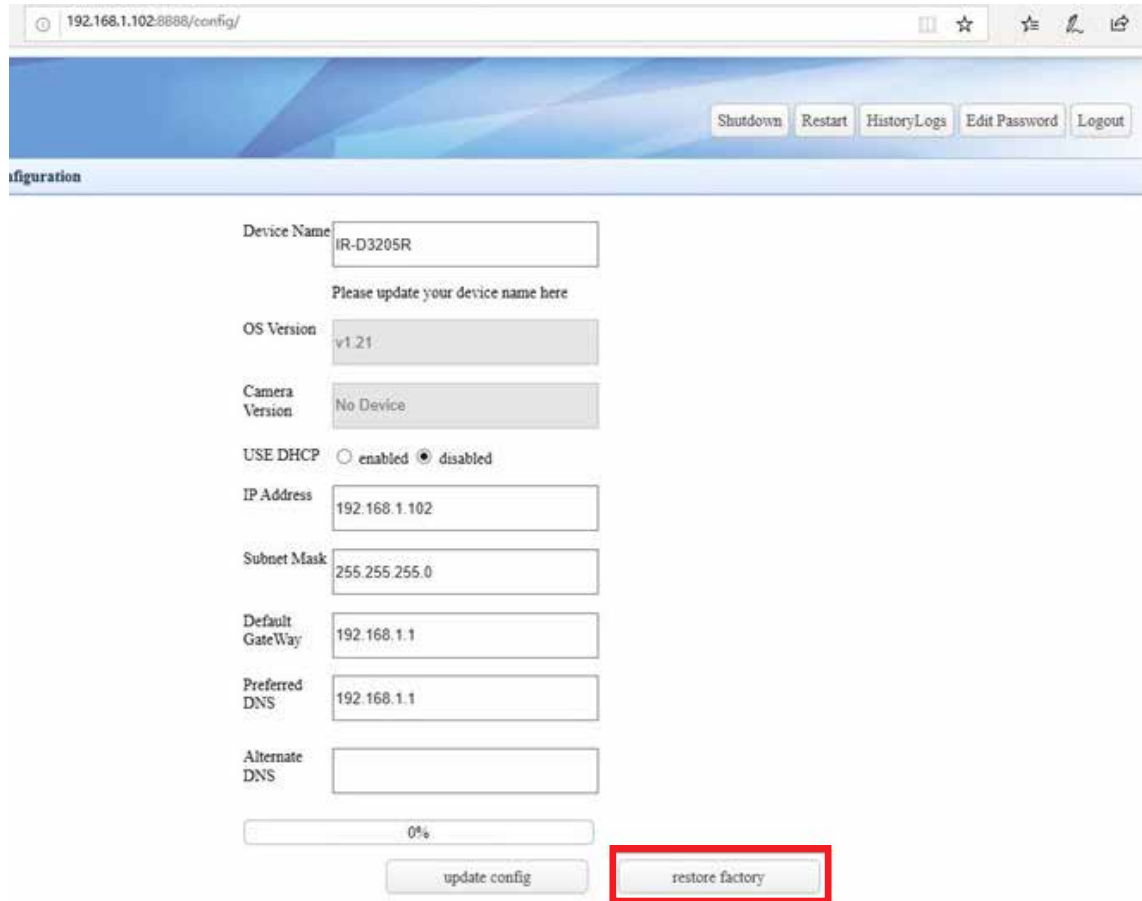

The screenshot shows a web browser window with the address bar displaying "192.168.1.102:8888/config/". The page has a blue header with navigation buttons: "Shutdown", "Restart", "History Logs", "Edit Password", and "Logout". Below the header, the word "figuration" is visible. The main content area contains several configuration fields:

- Device Name:
- Please update your device name here
- OS Version:
- Camera Version:
- USE DHCP: enabled disabled
- IP Address:
- Subnet Mask:
- Default GateWay:
- Preferred DNS:
- Alternate DNS:

At the bottom, there is a progress bar showing "0%" and two buttons: "update config" and "restore factory". The "restore factory" button is highlighted with a red rectangular border.

Step 2 All of the settings will be restored to factory default, Do you want to continue click "Ok".

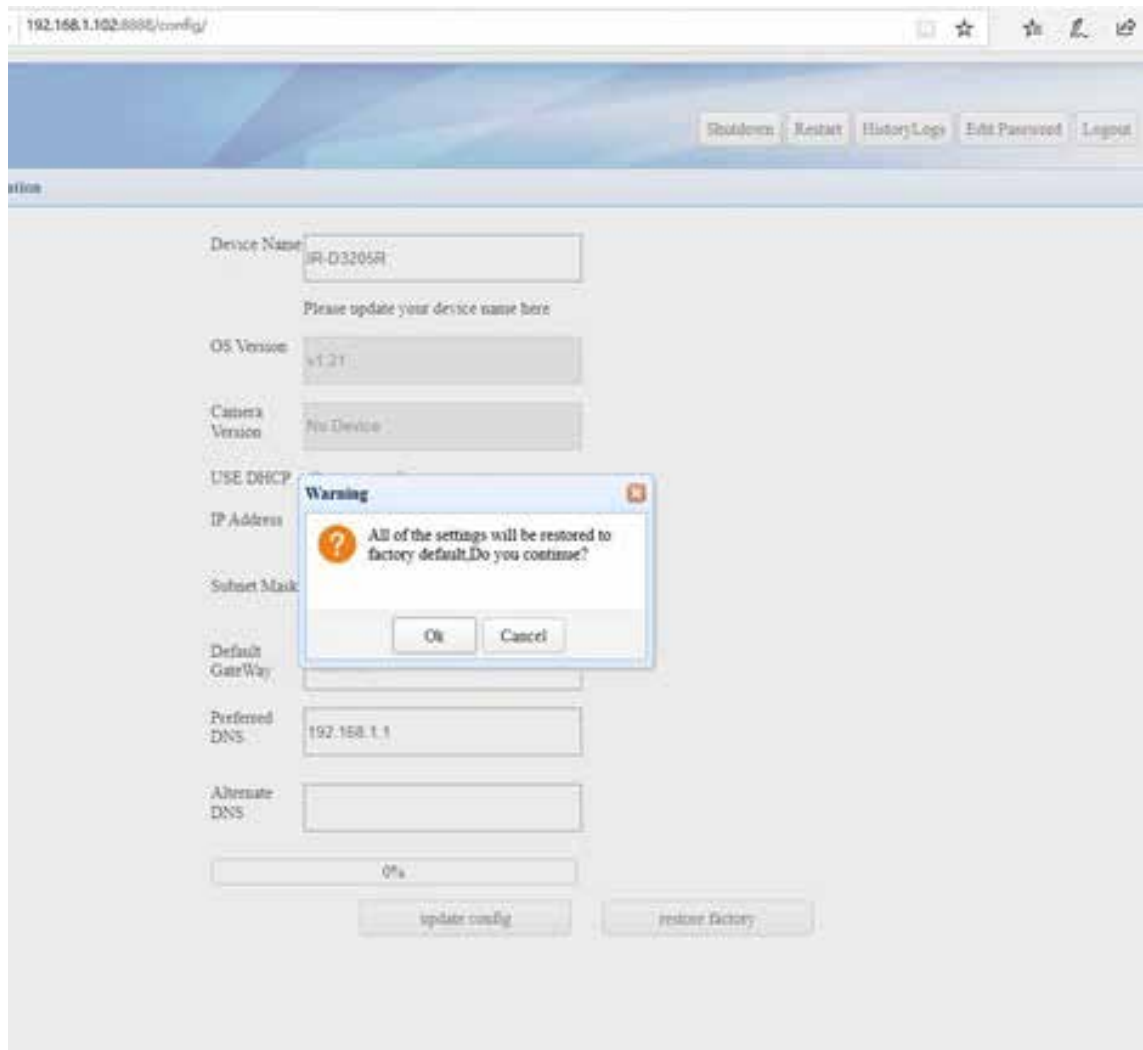

Step 3 Close the page, waiting for 30 seconds in Vecow utility, Search device, enter to login page, make sure all the items you changed before have been restored to factory settings, and the history logs has also been completely clear.

4.1.5 Camera Firmware Update

DVC-1000 camera firmware can be updated manually when Intel releases new firmware. The updating process takes approximately 3~5 minutes depending on your network condition. While updating firmware, make sure the power supply is constant throughout the process. The updating process is an advanced configuration, failure to comply to the instruction below may cause the camera to become unusable. In that case, send your camera back to Vecow for customer service.

Step 1 Copy the files that need to be updated to any folder on your computer first, then open the Vecow utility and select "Camera FW Update".

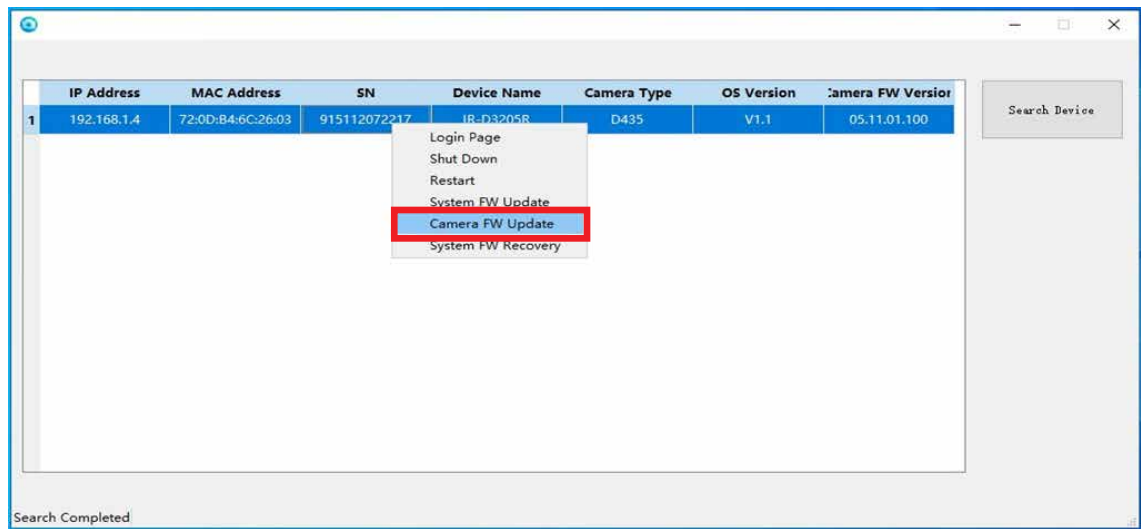

Step 2 Select the "Browser", then enter the folder where the file was saved before.

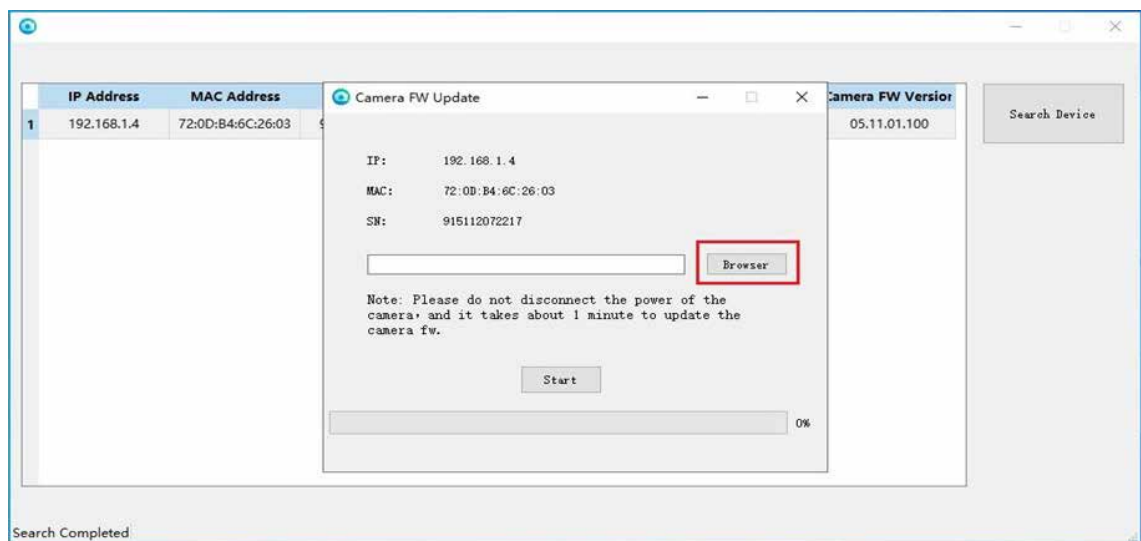

Step 3 Select the "firmware file and click Open".

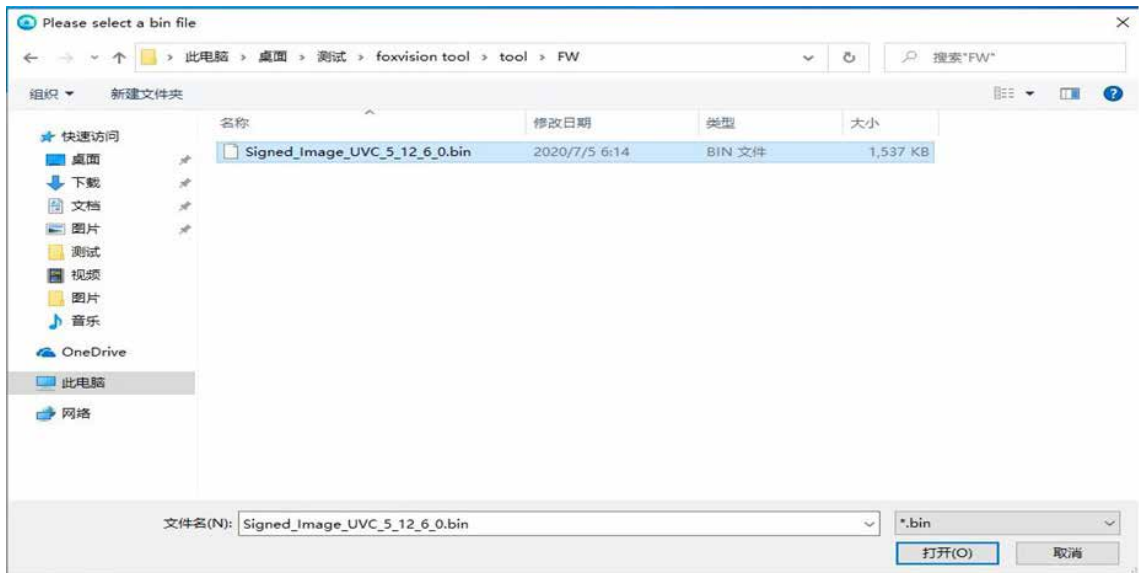
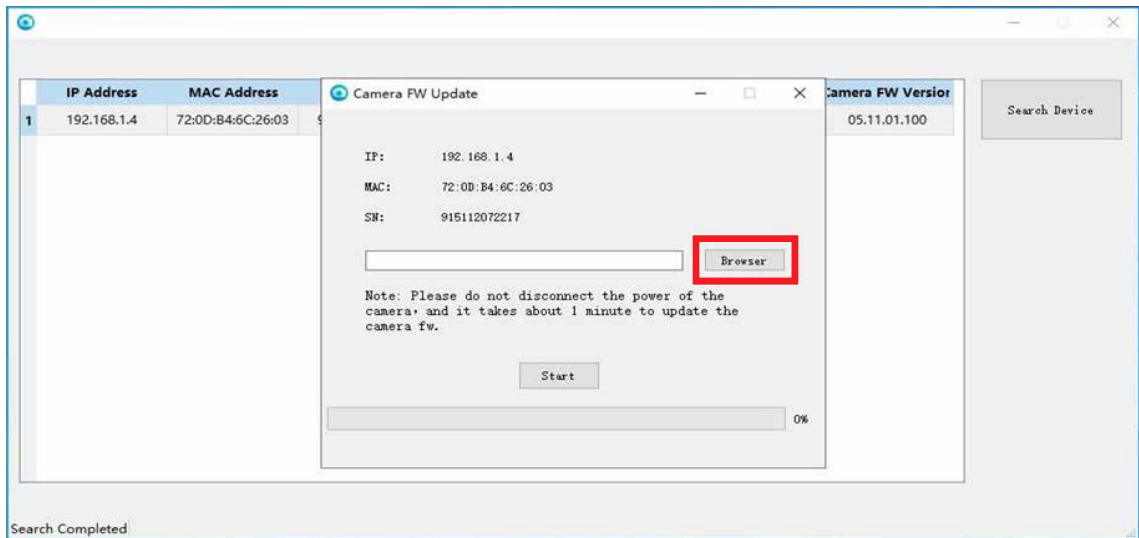

Step 4 Click start, a dialog box "Do you want to update" will pop up, select "Yes", camera FW update started.

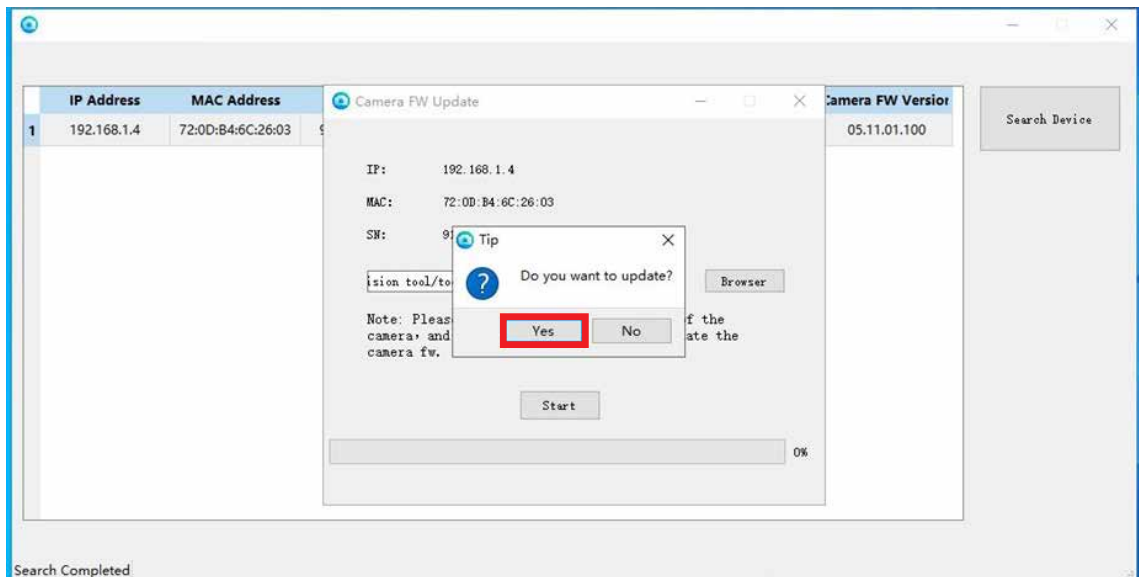

Step 5 Make sure the camera FW update successful.

Step 6 Select "Yes" to restart the system, open VECOW utility, search device, confirm that the camera FW has been updated to the latest version.

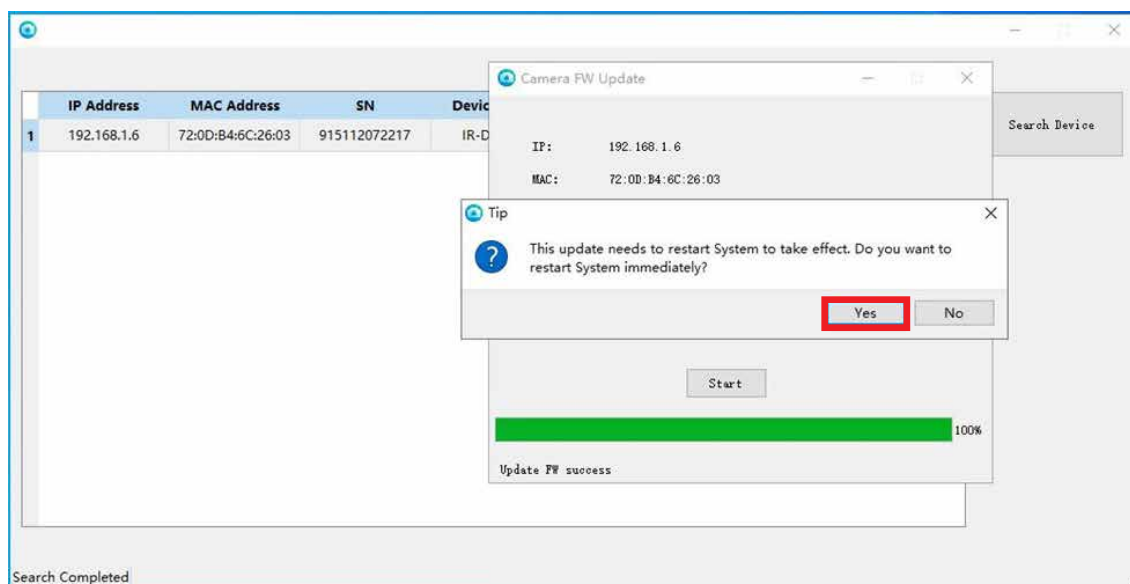

4.1.6 System Firmware Update

The DVC-1000 system firmware can be updated manually when new FW releases. The updating process takes approximately 30 minutes depending on your network condition. While updating firmware, make sure the power supply is constant throughout the process. The updating process is an advanced configuration, failure to comply to the instruction below may cause the camera to become unusable. In that case, send your camera back to VECOW for customer service.

Step 1 Copy the files that need to be updated to any folder on your computer first.

Step 2 Open the VECOW utility and select "System FW Update".

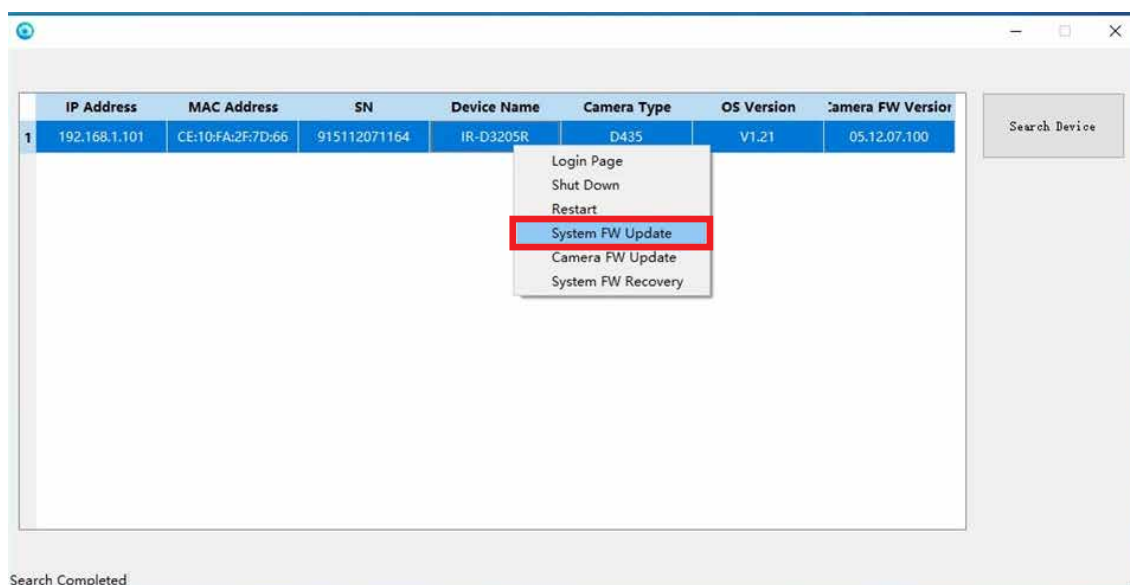

Step 3 Select "Browser" and choose the new version of firmware.

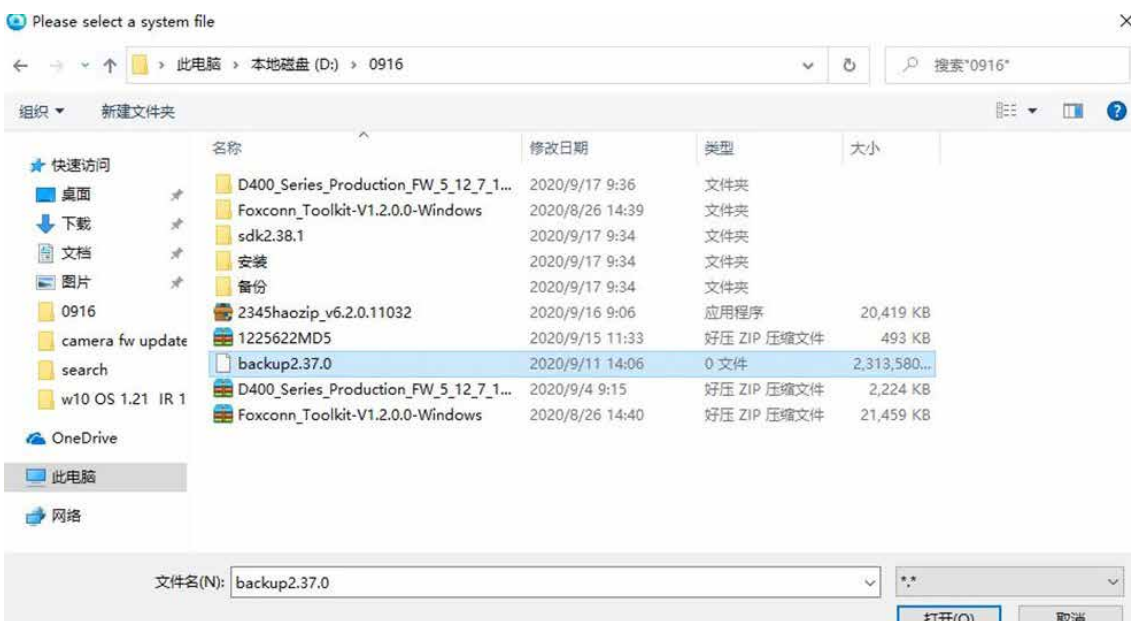
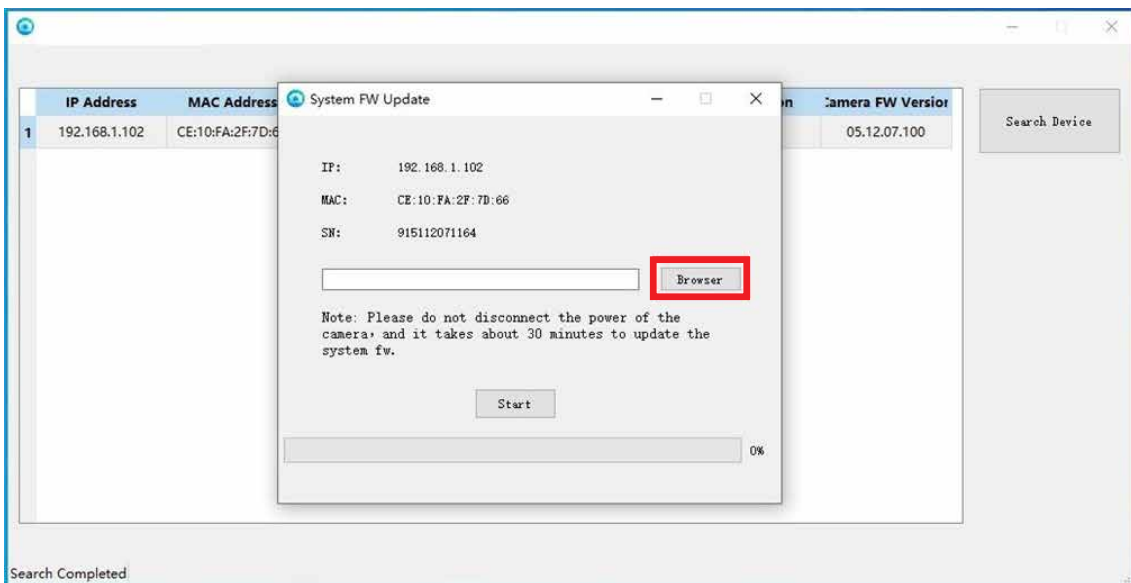

Step 4 Click "Start", When pop up "Do you want to update" → choose "Yes".

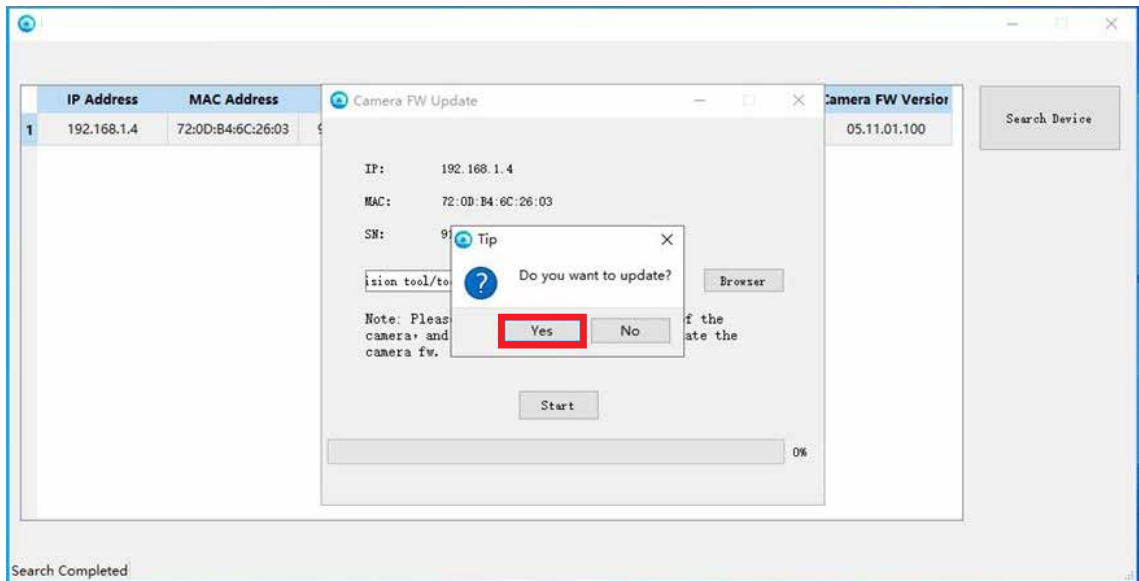

Step 5 The foxconn toolkit will transferring the firmware to the device.

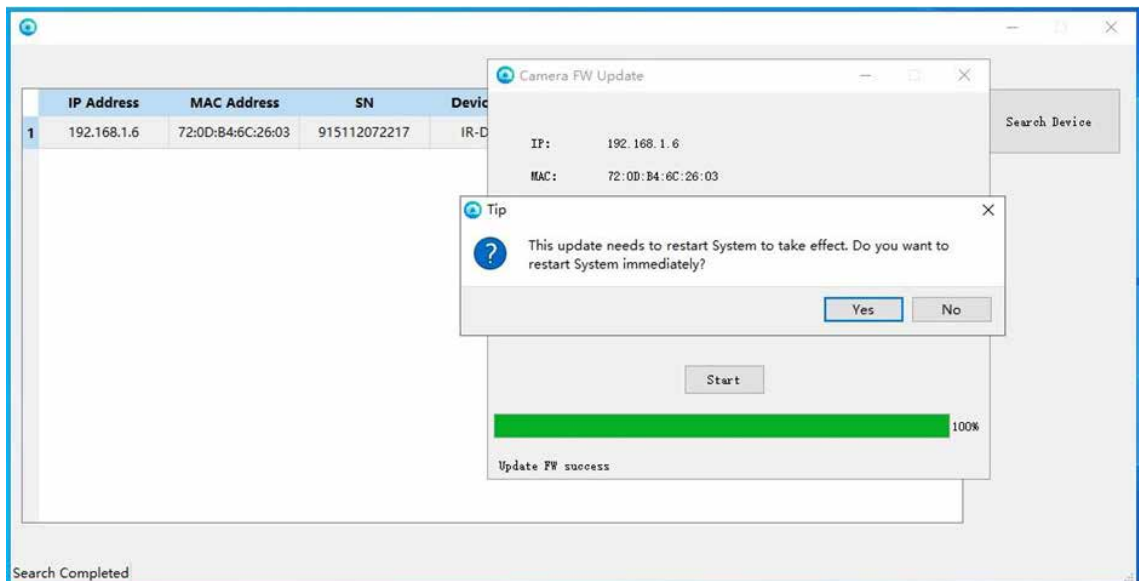

Step 6 When file transfer complete, server automatically enters to update F/W mode and The firmware update begins.

Step 7 When system firmware update successfully, the system will restart, it will take about 1 minute.

Step 8 The system FW Update successfully.

Step 9 Open VECOW utility, search device, confirm that the system FW has been updated to the latest version.

4.1.7 System Firmware Recovery

If your system files are damaged, you can recover your system through "System FW recovery". The recovery process takes approximately 30 minutes depending on your network condition. While recovery firmware, make sure the power supply is constant throughout the process. The recovery process is an advanced configuration, failure to comply to the instruction below may cause the camera to become unusable. In that case, send your camera back to VECOW for customer service.

Step 1 Open the VECOW utility, right click your device and select "System FW Recovery".

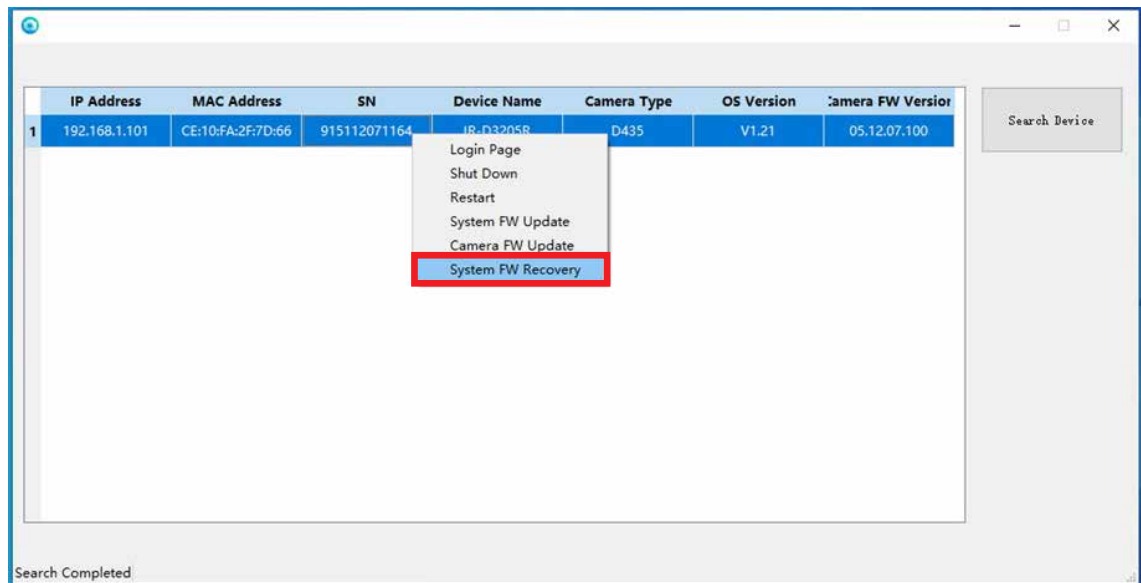

Step 2 Select "Recovery".

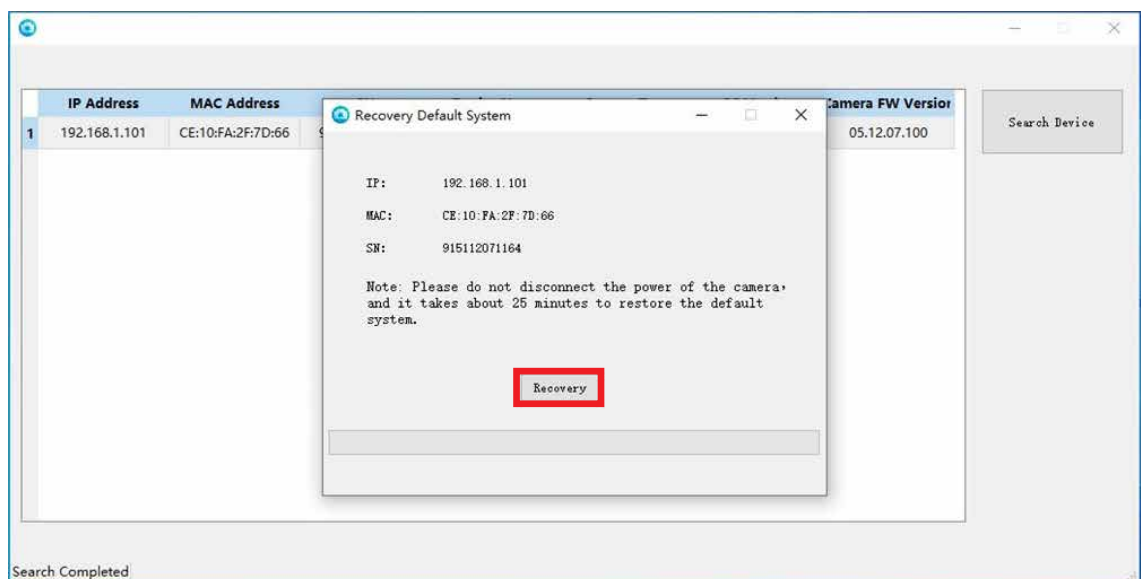

Step 3 Do you want to recovery default system → choose "Yes".

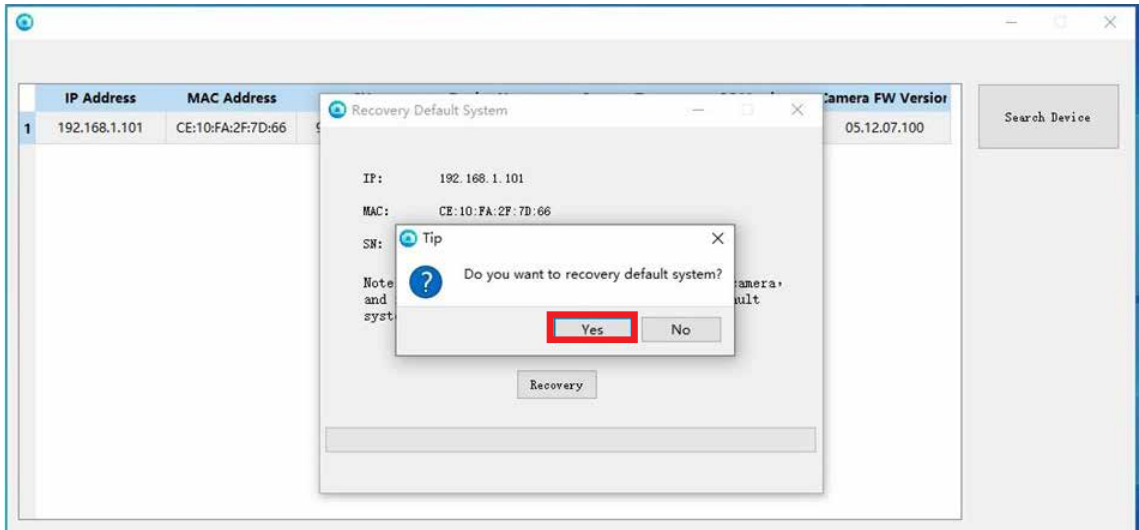

Step 4 The recovery progress begins.

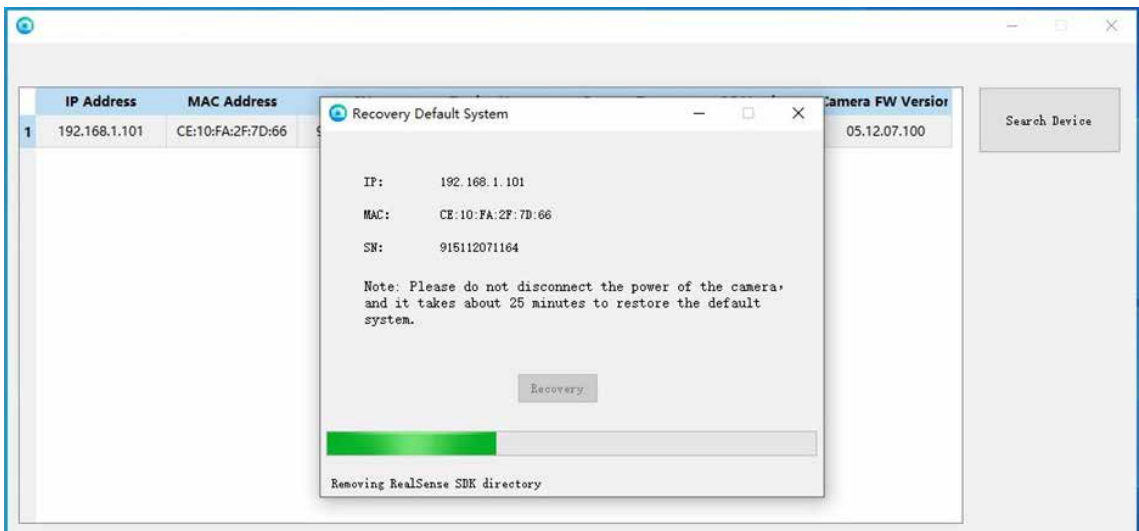

Step 5 When successfully recover system, the system will restart, it will take about 1 minute.

Step 6 System restart successful, the system recovery to default system now.

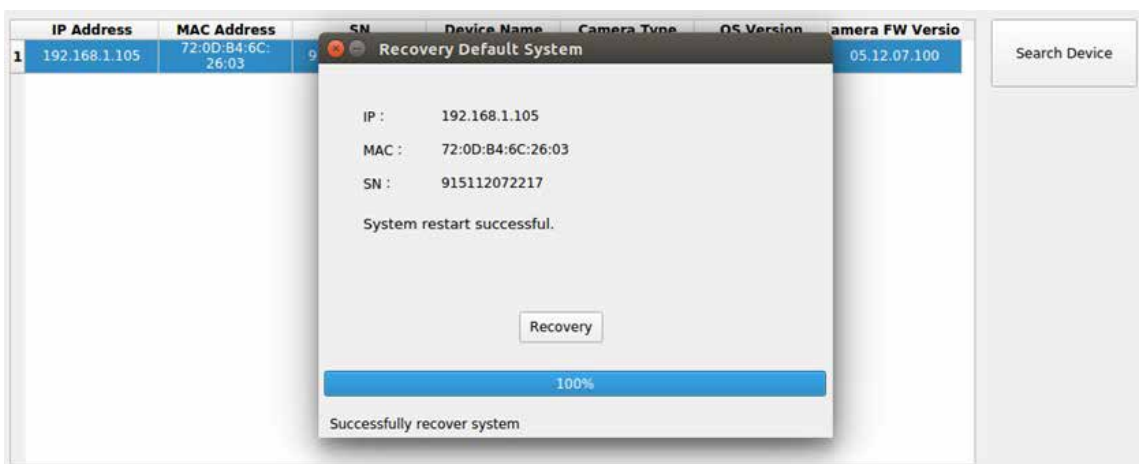

4.1.8 Shut Down

Step 1 Open VECOW utility, click "Search Device".

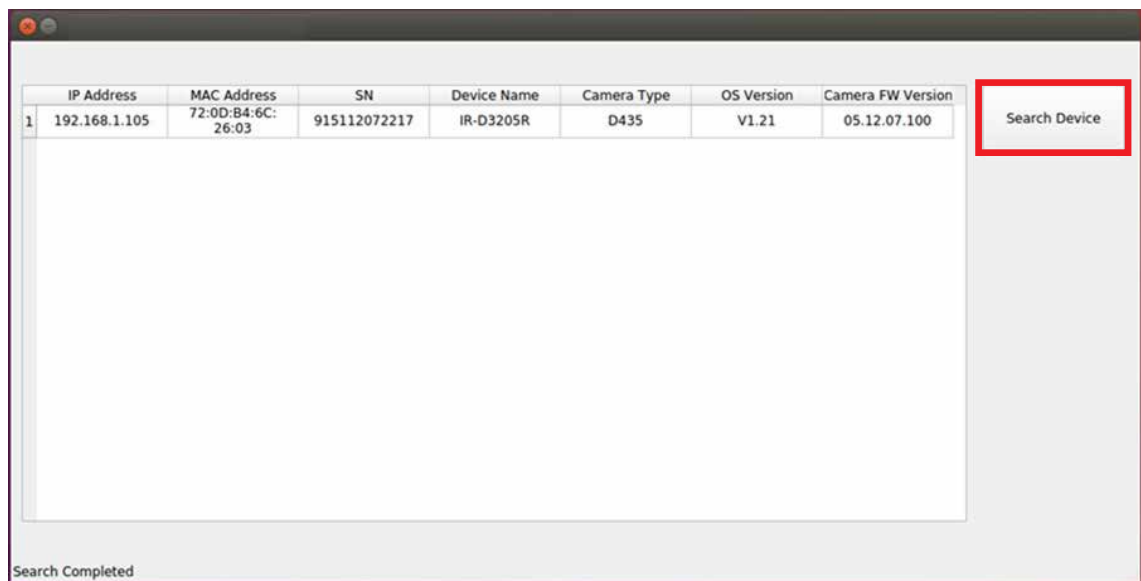

Step 2 Choose your device and right click mouse, select "Shut Down", "Do you want to shut down" choose "Yes".

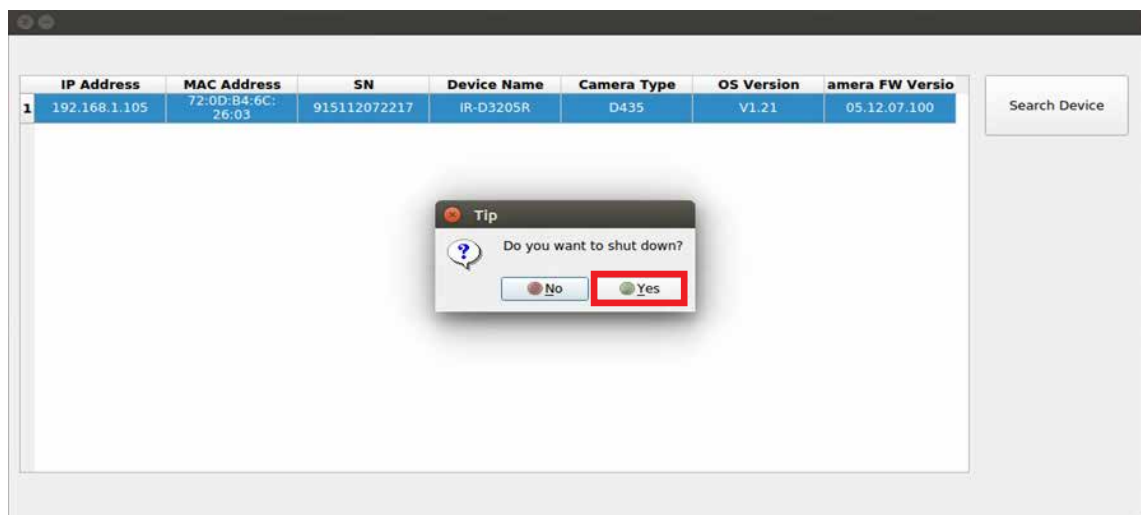
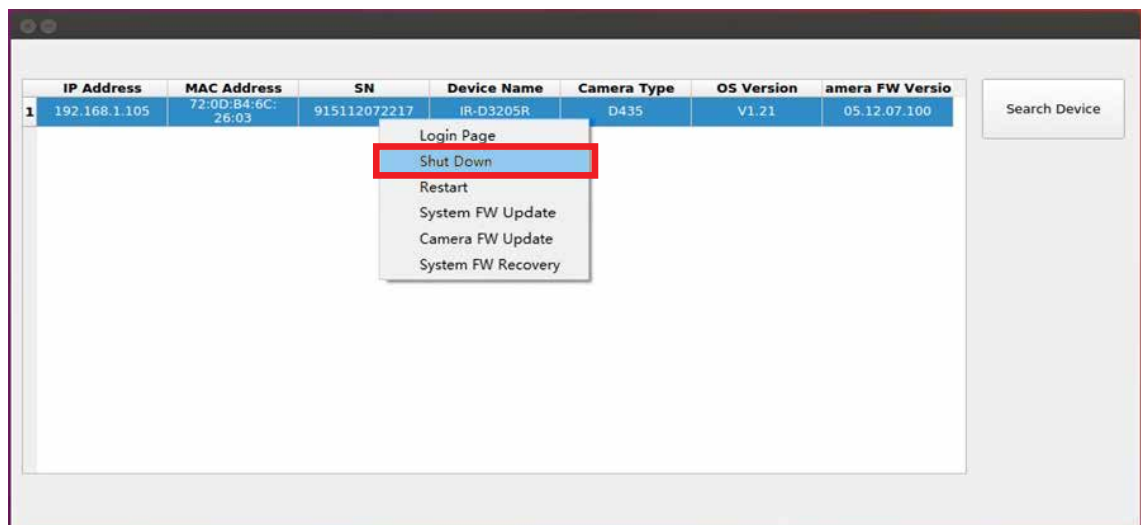

Step 3 In the lower left corner of the VECOW utility, it will show "System Shut Down".

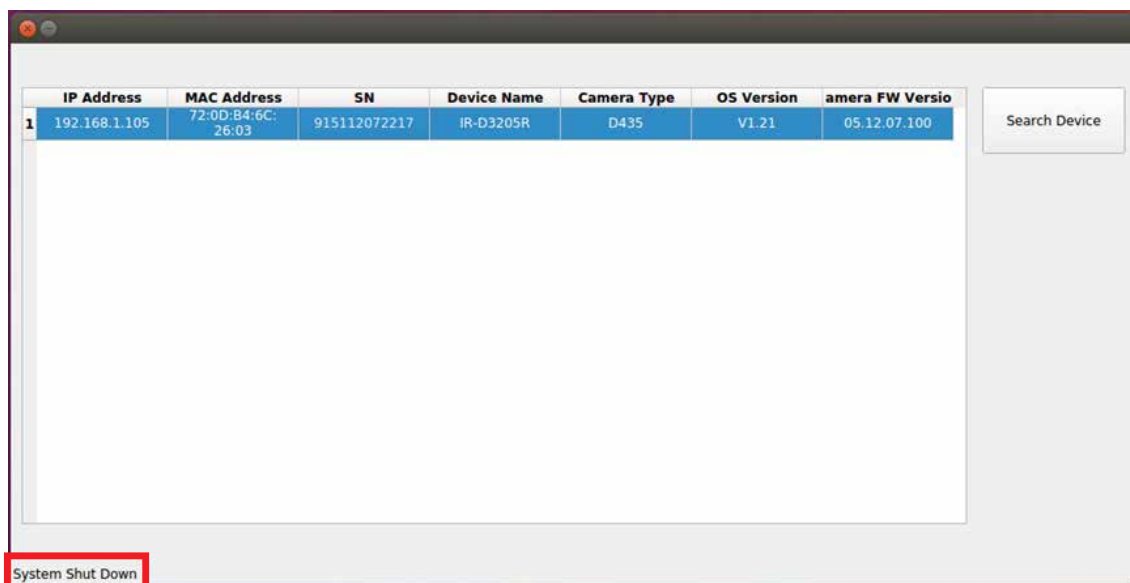

Step 4 You can shut down the device from the web page too.

IMPORTANT :

When the device shut down successfully, if you want to use the device again, you need to unplug the power cord and plug it in again, otherwise, it won't find the device.

4.1.9 Restart

Step 1 Open VECOW Utility, click "Search Device".

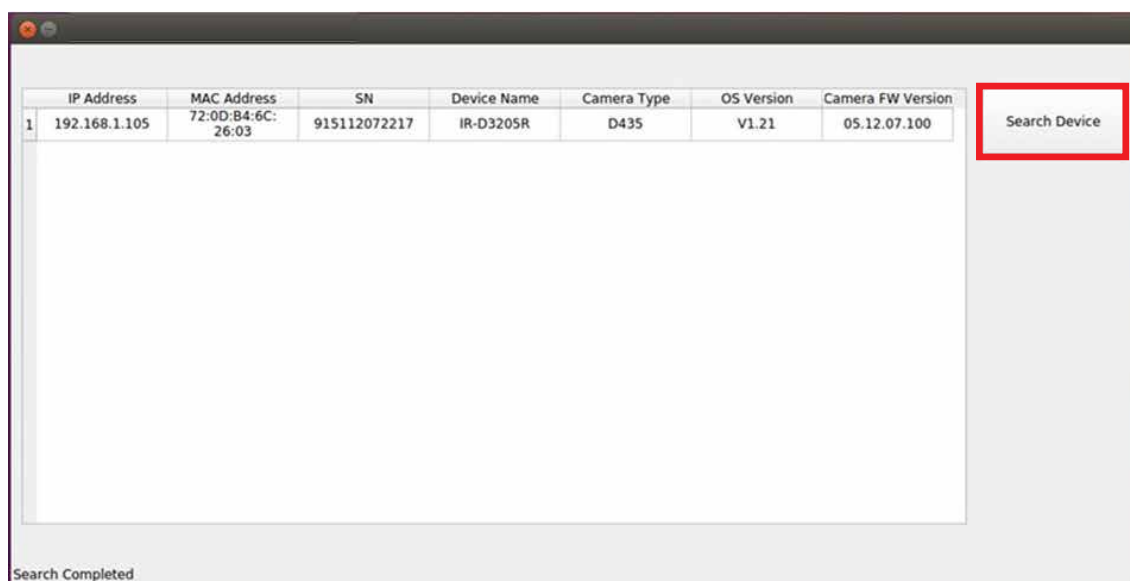

Step 2 Choose your device and right click mouse, select "Restart", "Do you want to restart" choose "Yes".

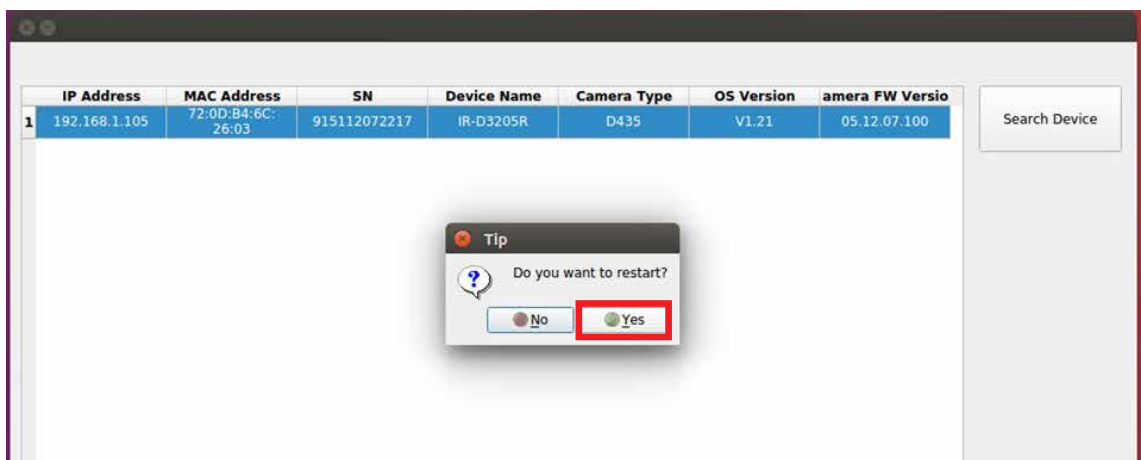
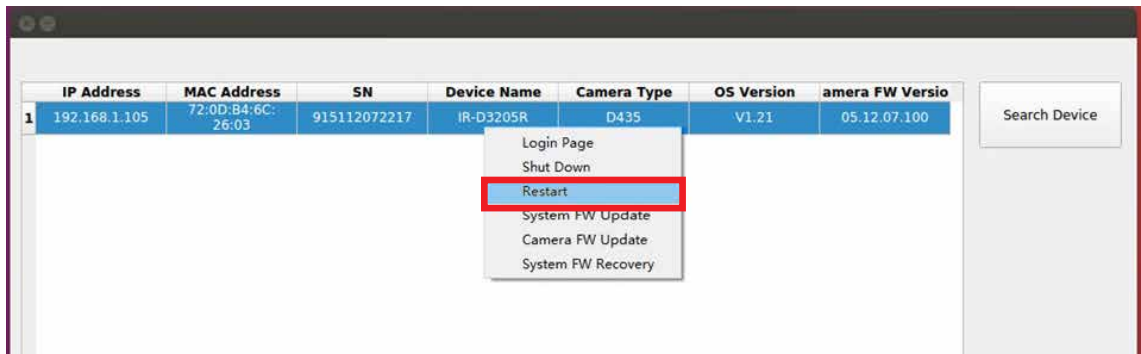

Step 3 In the lower left corner of the VECOW utility, it will show "System Restart".

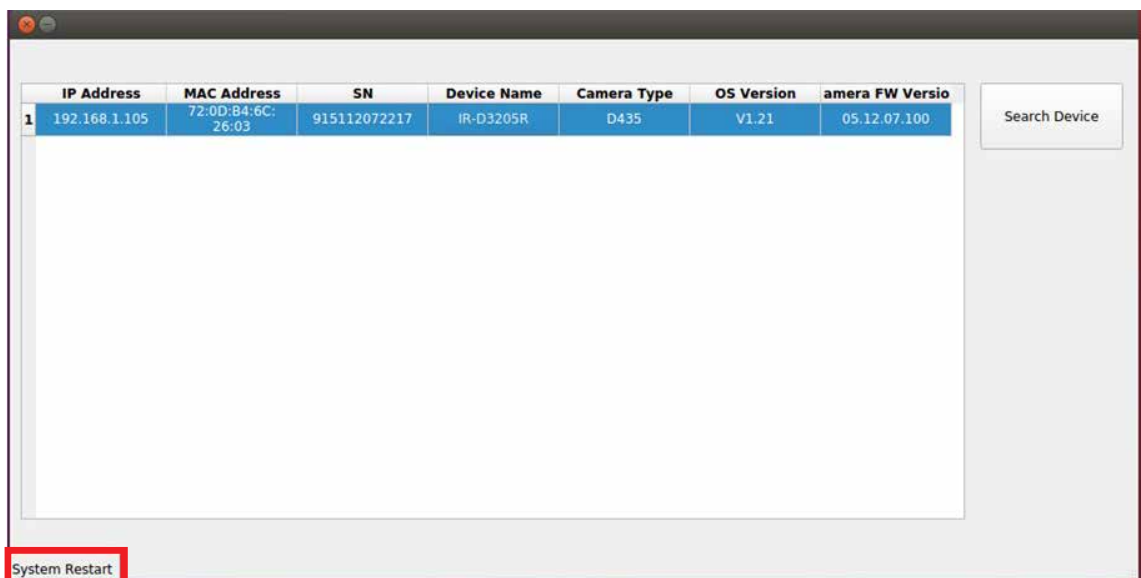

Step 4 When the device restart successful, wait about 30 seconds, then search device again, the VECOW utility will list your device under the sub network.

Step 5 You can restart the device from the web page too.

4.1.10 Accessing Web Interface

You can access your DVC-1000 camera from its own web interface.

Note that the web interface only supports **Microsoft Internet Explorer 10.0 or above**.

Step 1 Start your web browser. In the Search Bar, type in "http://your IP address:8888/" of your DVC-1000 camera.

Step 2 Entering from the webpage has the same function as VECOW utility.

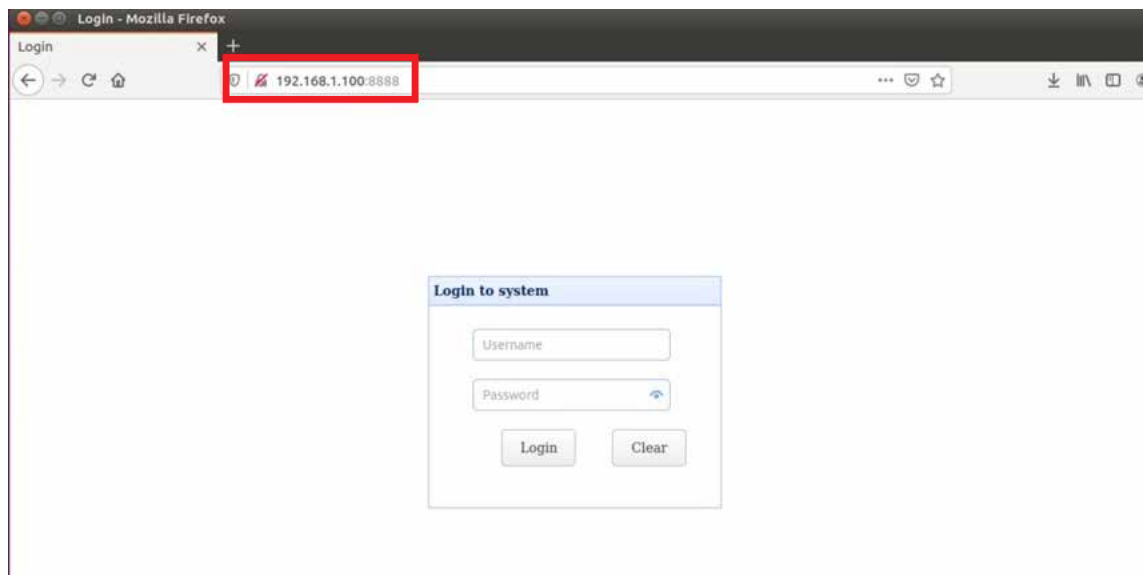

4.1.11 Accessing Camera Image

Step 1 Before you access the camera image, make sure the SDK has been installed successfully. Start Terminal and type the following command to open the Intel Realsense-viewer, the "Intel Realsense-Viewer" will pop up.

Command : Realsense-viewer



Step 2 Choose "Add Network Device".

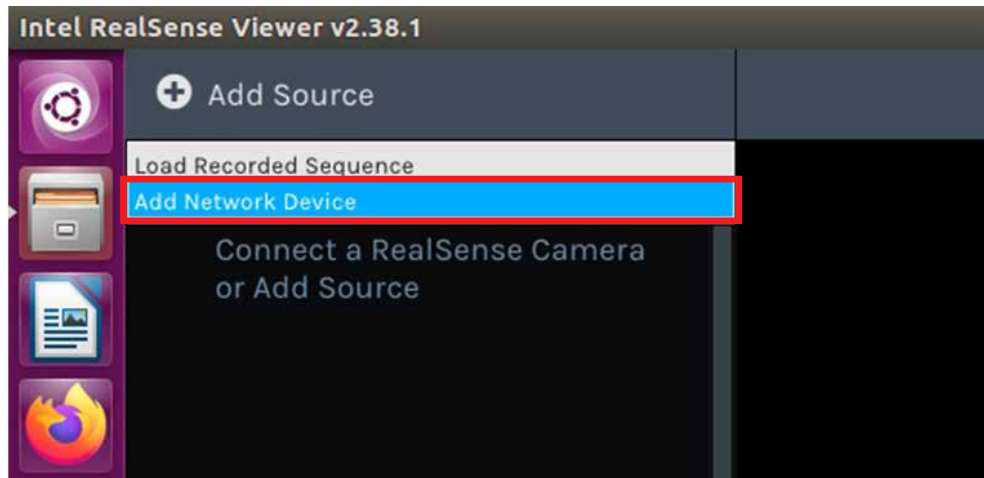

Step 3 Type in the IP Address (Use the VECOW utility to obtain the IP Address) then click "OK".

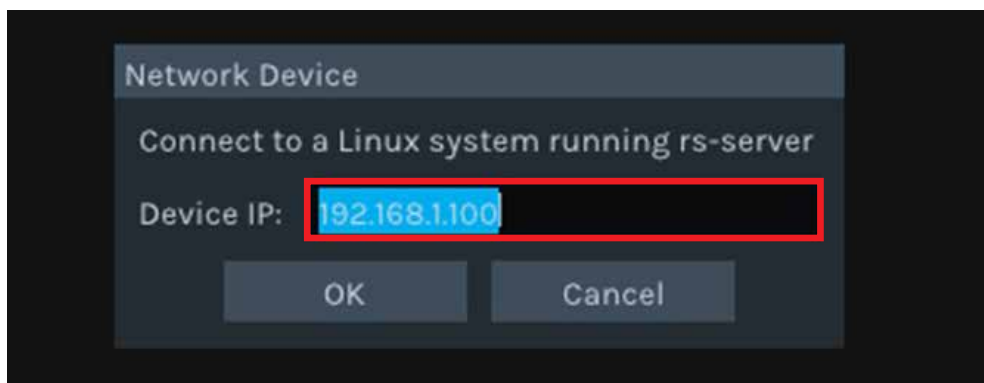

Step 4 On the left menu, select "Infrared1" and "Infrared2", click  for Stereo Module and RGB Camera.

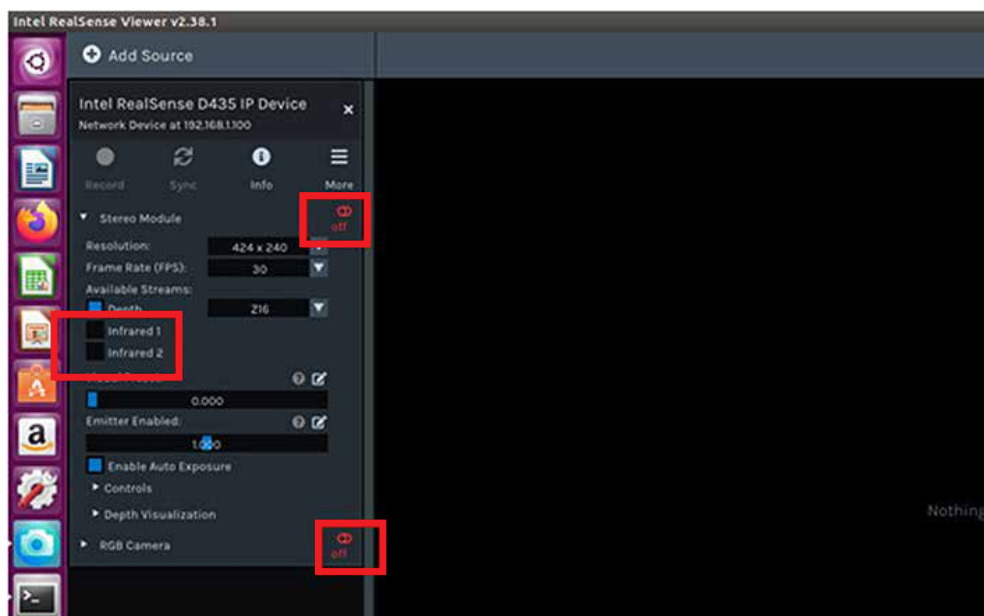

Step 5 You can see the RGB&Depth&IR camera now.

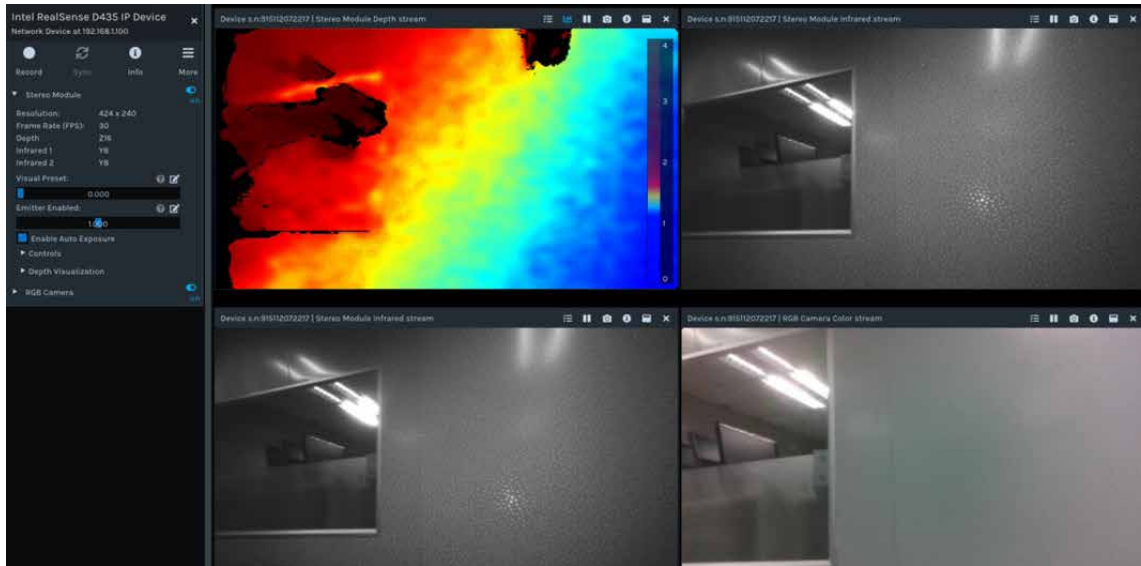

Step 6 For details on the remaining functions of Intel® RealSense™ viewer, refer to <https://www.intel.com/content/dam/support/us/en/documents/emerging-technologies/intel-realsense-technology/Intel-RealSense-Viewer-User-Guide.pdf>

4.2 Linux Version Utility

If you want to run Intel realsense-viewer, you need to install SDK first. It is an open source and available on <https://github.com/IntelRealSense/librealsense> You can choose to install online or manually.

4.2.1 Advance Configuration

Functions are the same as Window version include

- Searching Camera IP Address
- Change IP Address
- Edit password
- Restore factory
- Camera Firmware Update
- System Firmware Update
- System Firmware Recovery
- Shut down
- Restart

4.2.2 Accessing Web Interface

Step 1 Before you access the camera image, make sure the SDK has been installed successfully. Start Terminal and type the following command to open the intel realsense-viewer, the "Intel Realsense-Viewer" will pop up.

Command : Realsense-viewer





```
g@g-Veriton-M4620G: ~  
g@g-Veriton-M4620G:~$ realsense-viewer  
g@g-Veriton-M4620G:~$ realsense-viewer
```

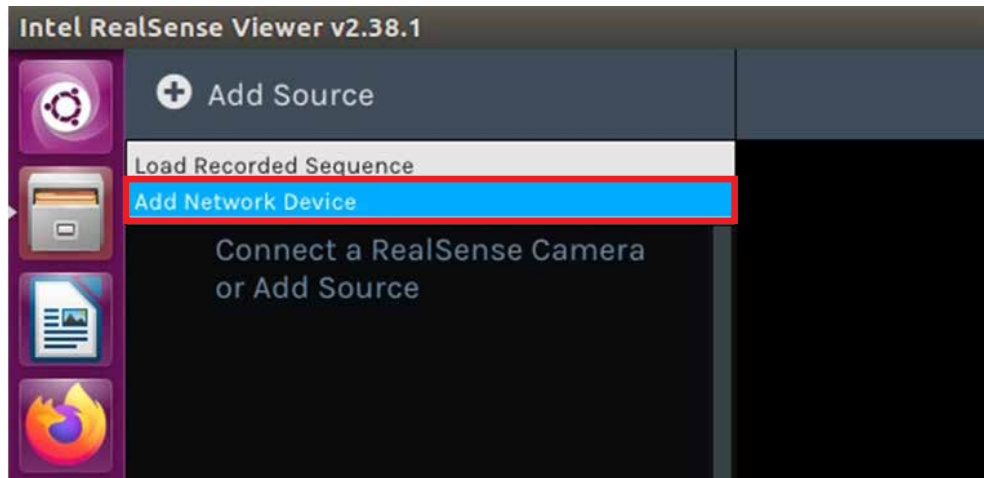

Step 2 Choose "Add Network Device".

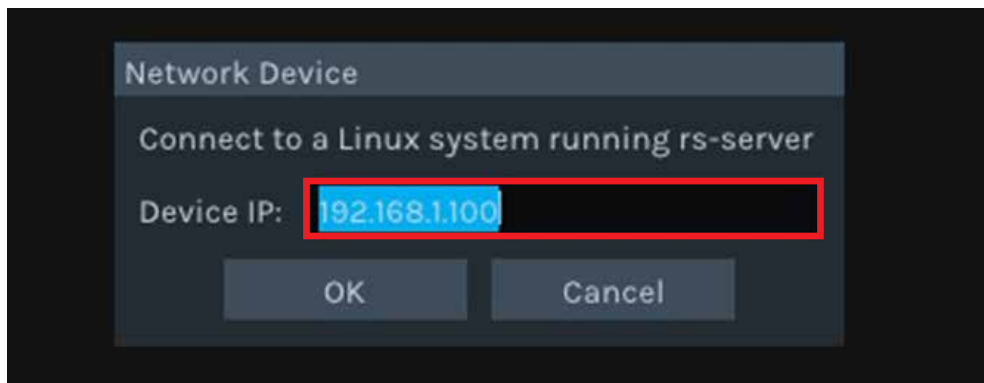

Step 3 Type in the IP Address (Use the VECOW utility to obtain the IP Address) then click "OK".

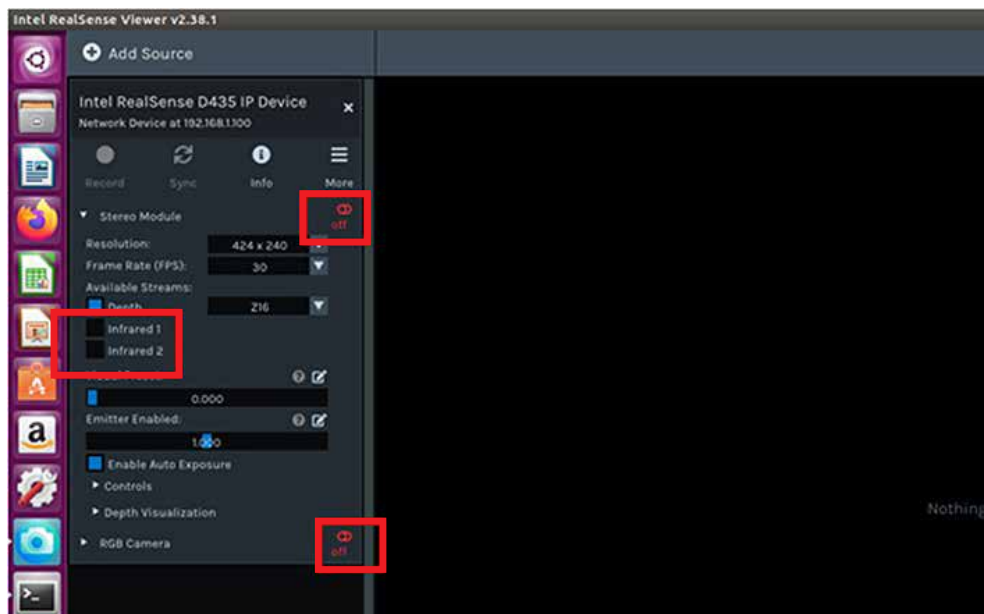

Step 4 On the left menu, select "Infrared1" and "Infrared2", click  for Stereo Module and RGB Camera.



Step 5 You can see the RGB&Depth&IR camera now.

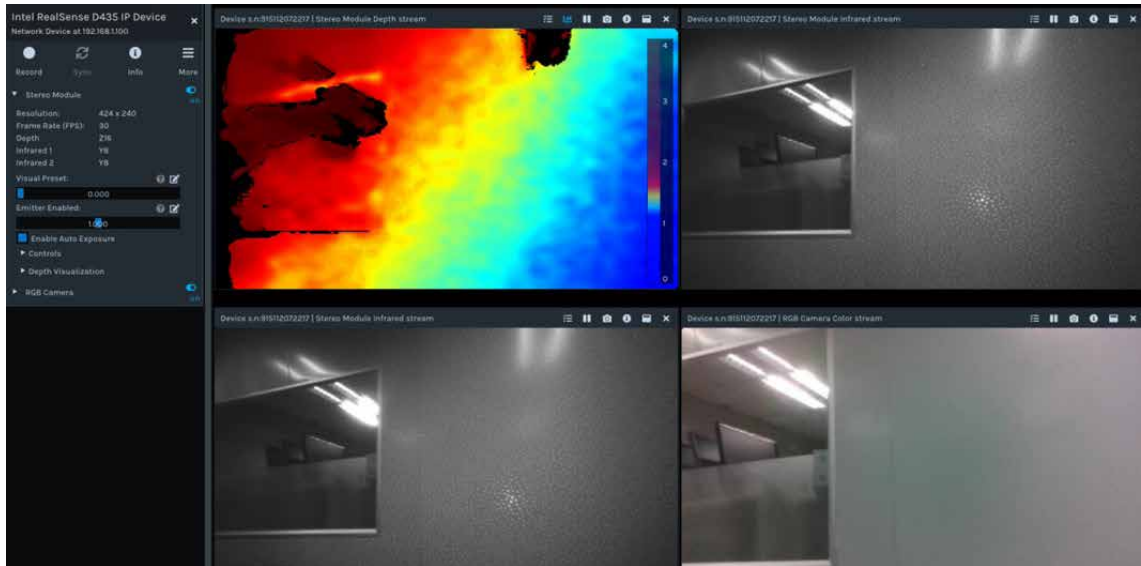

Step 6 For details on the remaining functions of Intel® RealSense™ viewer, refer to <https://www.intel.com/content/dam/support/us/en/documents/emerging-technologies/intel-realsense-technology/Intel-RealSense-Viewer-User-Guide.pdf>

A

APPENDIX A : Reset Camera

A.1 Function Description

If for any reason the camera failed to work as intended, you can restore the camera to its factory default setting by shorting the Pin 3 (GND) and Pin 4 (HW Reset) simultaneously in the M12 interface of the camera.

M12 8-pin male connector cable Pinout

| Pin No. | Definition | Pin No. | Definition |
|---------|------------|---------|------------|
| 1 | 12V-in | 2 | GPIO_A0 |
| 3 | GND | 4 | HW Reset |
| 5 | SYNC | 6 | GND |
| 7 | 12V | 8 | GPIO_A7 |

Step 1 Insert a pin into the Pin 3 (GND) and Pin 4 (HW Reset) of the camera and hold 30 seconds.

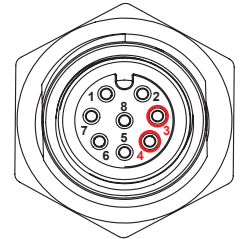

Step 2 Re-plug the camera. The camera is restored to its default settings.

A.2 Frequently Question Answer

Question :

Sometimes it show "Error : Connection to servers failed" when opened "Intel Realsense Viewer".

Answer :

When searching device, the device is about to reboot, When open the " Intel Realsense viewer 2.37.0" , the device has rebooted. We recommend waiting for 1 minute after the device restarts before searching for the device.



For further support information, please visit www.vecow.com

This document is released for reference purpose only.

All product offerings and specifications are subject to change without prior notice.

No part of this publication may be reproduced in any form or by any means, electric, photocopying, or recording, without prior authorization from the publisher.

The rights of all the brand names, product names, and trademarks belong to their respective owners.

© Vecow Co., Ltd. 2023. All rights reserved.